

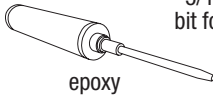











# APTOS™ BOLLARD, HARDWIRED

SURFACE MOUNT INSTALLATION INSTRUCTIONS

MOUNTING KIT (SOLD SEPARATELY)		TOOLS NEEDED			
	5/16" and 3/16" hex bit for tamper-resistant bolts				
					
			1/4", 1/2" & 7/8" drill bits for concrete		

**STEP BY STEP** FOR ALL SURFACE MOUNTED HARDWIRED APTOS BOLLARDS

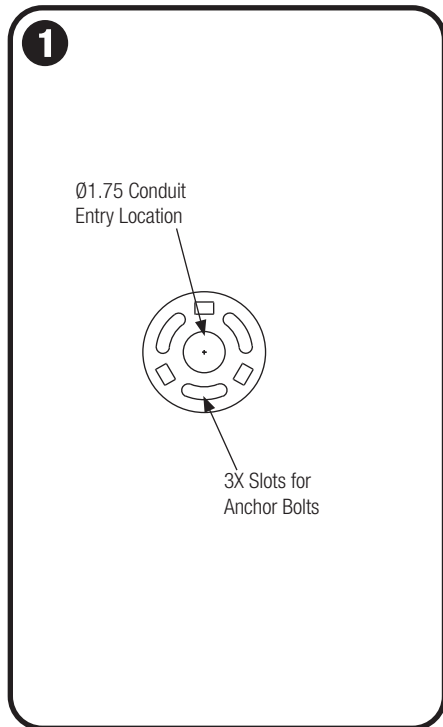

### 1 Prepare the incoming power

- Before pouring concrete footer, run properly sized conduit and cabling to each luminary location according to local code requirements. Refer to figure above for dimensions for conduit entry envelope size and location on luminary.

**Forms+Surfaces is not responsible for site preparation and footings.**

Note: Conduit should not protrude more than 2" above mounting surface.

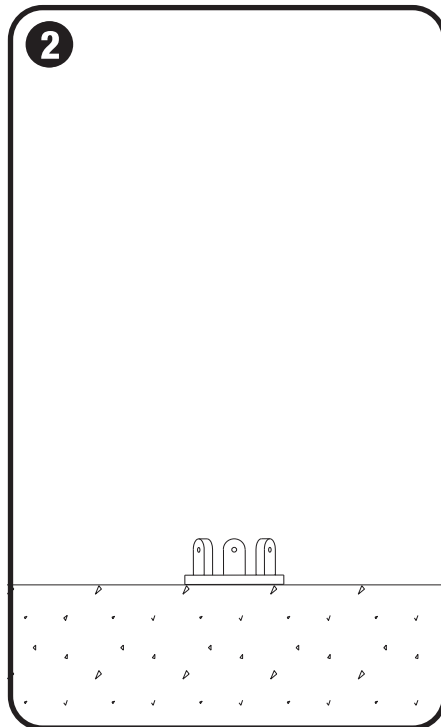

### 2 Mark hole locations

- Place base plate in desired location. Mark center of each hole location with a pencil.

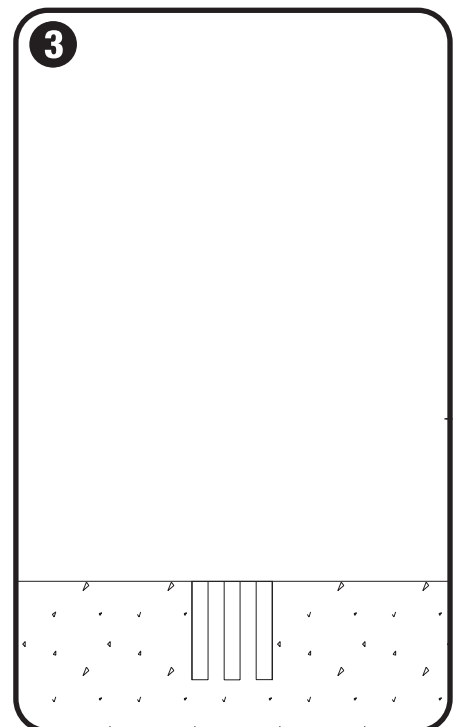

### 3 Drill holes

- Use hammer drill to drill 5" deep x 7/8" diameter anchor hole at each marked location using a 7/8" drill bit suitable for concrete drilling.

NOTE: Forms+Surfaces recommends starting holes with 1/4" diameter drill bit followed by 1/2" and finally 7/8" for maximum accuracy.

# APTOS™ BOLLARD, HARDWIRED

SURFACE MOUNT INSTALLATION INSTRUCTIONS

## STEP BY STEP FOR ALL SURFACE MOUNTED APTOS HARDWIRED BOLLARDS

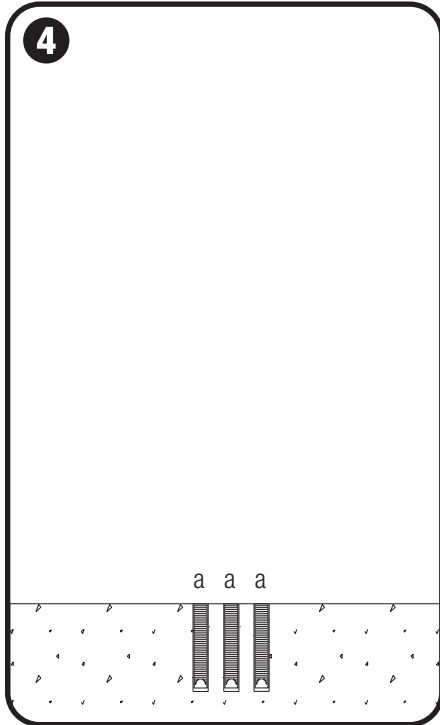

### Fill holes & insert anchors

- Use compressed air and steel wire brush to clean each anchor hole in accordance with epoxy instructions.
- Use epoxy in epoxy gun to fill each anchor hole 5/8 of the hole depth in accordance with epoxy instructions.
- Insert 1/2"-13 x 5" epoxy anchors (a) into each anchor hole so anchor top is flush with ground. Allow proper curing time according to cure schedule on epoxy instructions before moving on to Step 5.

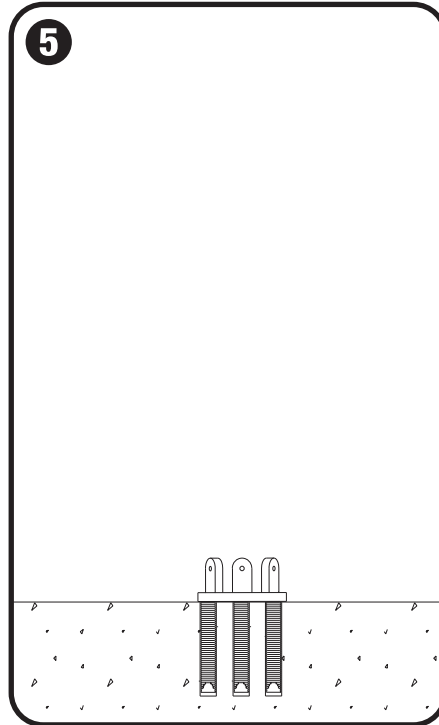

### Position base plate

- Position base plate so that the mounting holes line up with anchors.

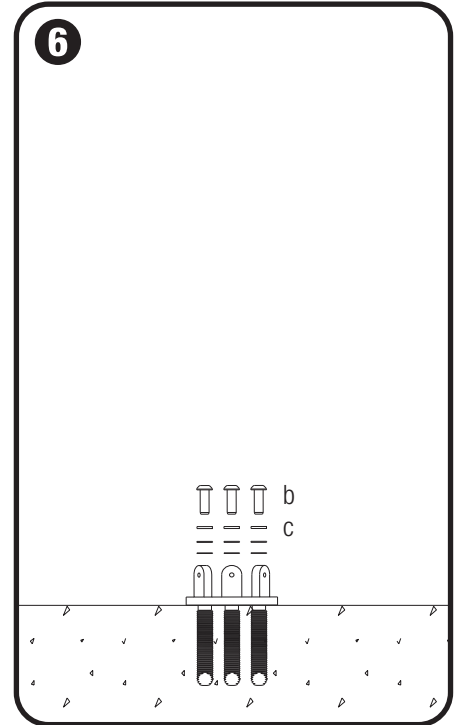

### Attach base plate

- Slide 1/2" stainless steel lock washer (c), onto each 1/2"-13 x 1-1/2" tamper-resistant button head cap bolt (b).
- Insert bolts into mounting holes in base plate and thread into anchors using 5/16" hex bit for tamper-resistant bolts.

# APTOS™ BOLLARD, HARDWIRED

SURFACE MOUNT INSTALLATION INSTRUCTIONS

## STEP BY STEP FOR ALL SURFACE MOUNTED APTOS HARDWIRED BOLLARDS

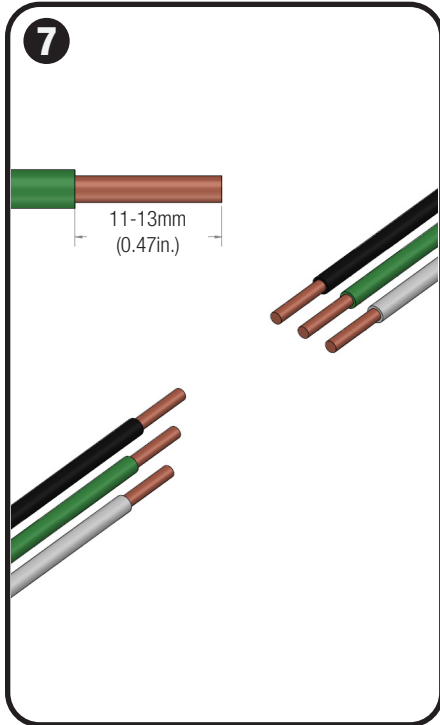

### Locate and prepare wires

Note: Installation should be performed only by qualified individuals.

- Before proceeding with wiring of luminary, check to ensure that all applicable site wiring and safety codes have been followed.
- Locate wires at base of light fixture.
- Ensure power supply is shut off and circuit being used is isolated.
- Prepare wiring from site junction box and bollard by stripping and removing 11-13mm (.47") of insulation.

Note: Wire used should be 22-14 AWG copper conductors.

Caution: Installation of a surge protector as part of each unit's wiring is recommended.

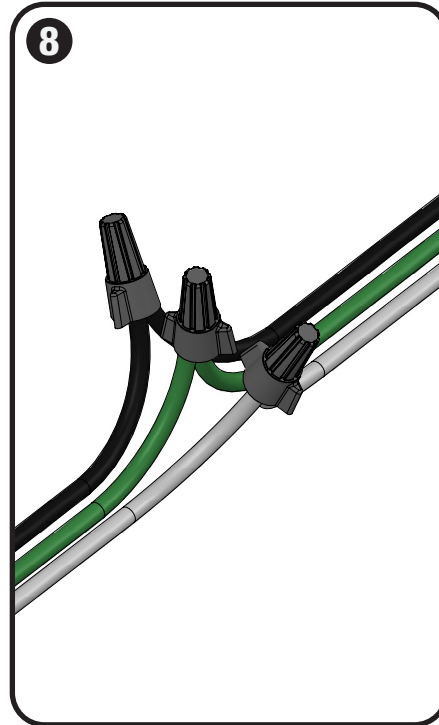

### Connect wires

- Insert ground (green), neutral (white), and positive (black) wires into wire nuts, being sure to match wire color codes from junction box to bollard.
- Tighten wire nuts until exposed wire ends are below bottom of wire nut.
- Inspect all wiring and connections before.

Caution: Light fixture rated for 120-277 VAC power.

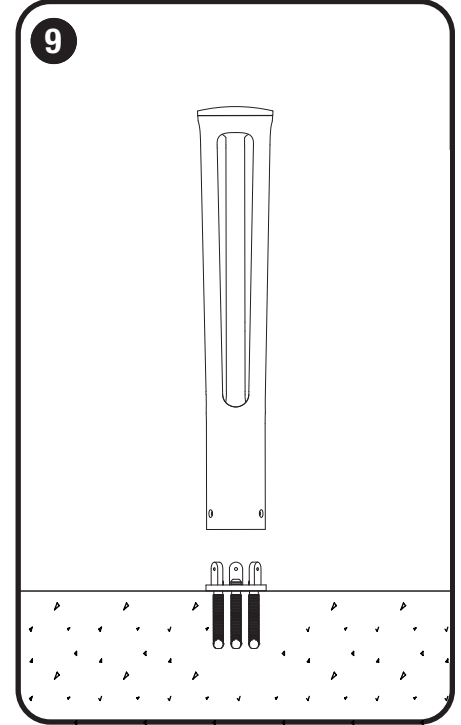

### Place bollard

- Slide bollard over base plate, lower and align mounting holes.

# APTOS™ BOLLARD, HARDWIRED

SURFACE MOUNT INSTALLATION INSTRUCTIONS

## STEP BY STEP FOR ALL SURFACE MOUNTED APTOS HARDWIRED BOLLARDS

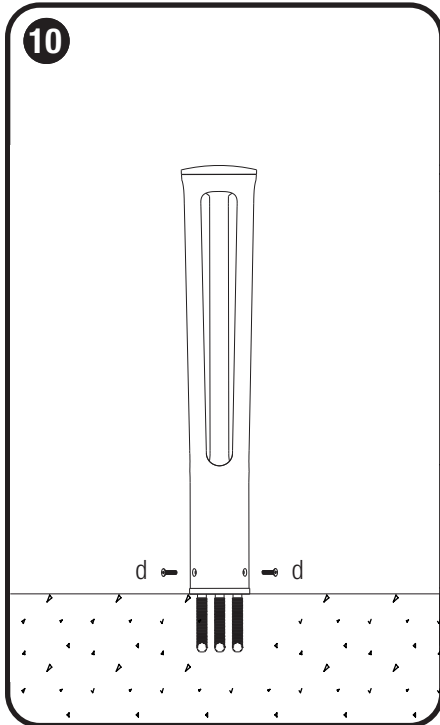

### Attach bollard to base plate

- Thread 5/16"-18x1" tamper-resistant flat head bolts (d) into each hole.
- Use 3/16" hex bit for tamper-resistant bolts to tighten all bolts until snug.