

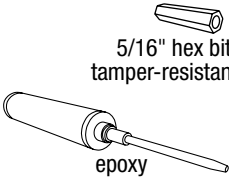

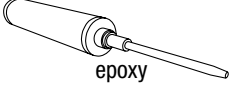

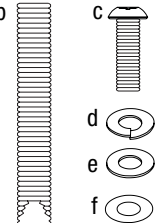

APEX™ TABLE ENSEMBLE

SURFACE MOUNT (ALUMINUM SLAT) INSTALLATION INSTRUCTIONS

INCLUDED	MOUNTING KIT (SOLD SEPARATELY)	TOOLS NEEDED
 <p>a</p>	 <p>5/16" hex bit for tamper-resistant bolts</p>  <p>epoxy</p>  <p>b, c, d, e, f</p>	 <p>7/32" Allen wrench</p>  <p>pencil</p>  <p>1/4", 1/2" & 7/8" drill bits for concrete</p>  <p>hammer drill</p>  <p>steel wire brush</p>  <p>epoxy gun</p>

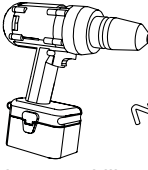
STEP BY STEP FOR ALL APEX TABLE ENSEMBLES WITH ALUMINUM SLATS (TABLE & TWO BENCHES SHOWN)

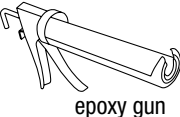
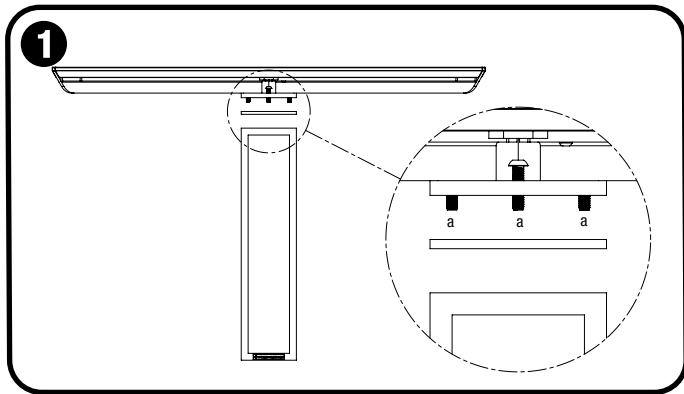

1 Attach table top to column

- Use 7/32" Allen wrench to attach table top to column using four (4) 3/8" -16 x 1-1/2" button head cap bolts (a). **Ensure spacer plate is between table top and column.**

NOTE: Table top and column are not freestanding and must be supported during this step.

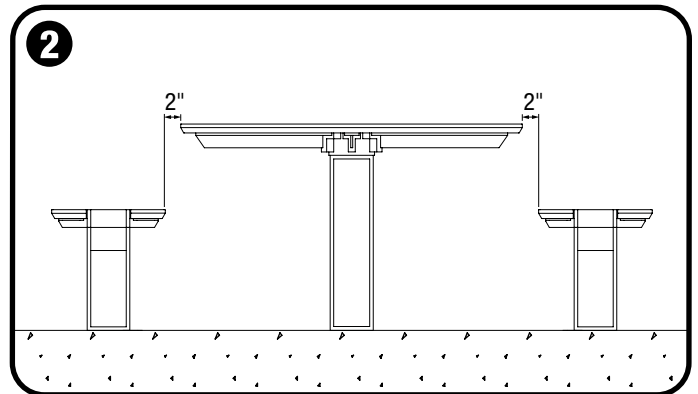

2 Mark hole locations

- Place benches (if included/surface mounted) and table in desired location. Mark center of each hole location with a pencil.
- The recommended gap between the bench edge and table edge is 2". Benches should be centered horizontally, 4" in from table sides.

NOTE: Table and benches are not freestanding and must be supported during this step.

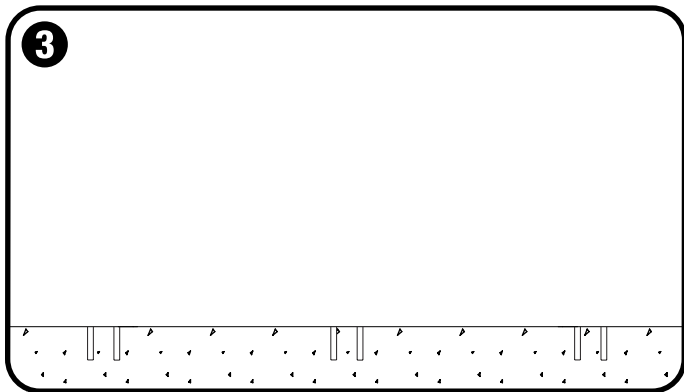

3 Drill holes

- Use hammer drill to drill 5" deep x 7/8" diameter anchor hole at each marked location using a 7/8" drill bit suitable for concrete drilling.

NOTE: Forms+Surfaces recommends starting holes with 1/4" diameter drill bit followed by 1/2" and finally 7/8" for maximum accuracy.

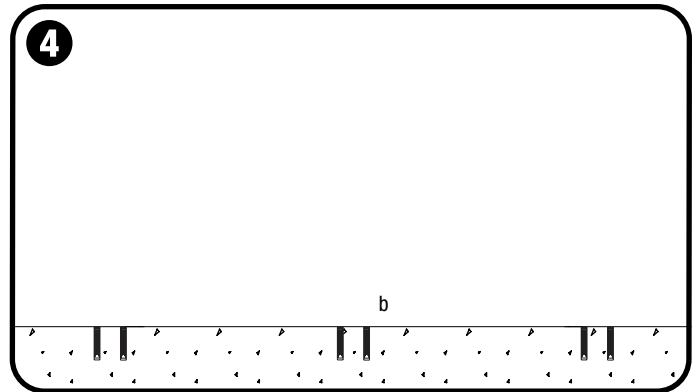

4 Fill holes & insert anchors

- Use compressed air and steel wire brush to clean each anchor hole in accordance with epoxy instructions.
- Use epoxy in epoxy gun to fill each anchor hole 5/8 of the hole depth in accordance with epoxy instructions.
- Insert 1/2"-13 x 5" epoxy anchor (b) into each anchor hole so top is flush with ground. Allow proper curing time according to epoxy cure schedule.

APEX™ TABLE ENSEMBLE

SURFACE MOUNT (ALUMINUM SLAT) INSTALLATION INSTRUCTIONS

STEP BY STEP FOR ALL APEX TABLE ENSEMBLES WITH ALUMINUM SLATS (TABLE & TWO BENCHES SHOWN)

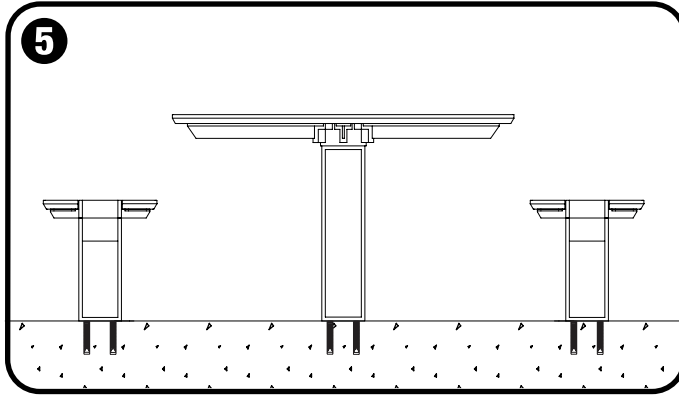

Position benches and table

- After recommended curing time, position benches and table over anchors so that mounting holes line up with anchors.

NOTE: Table and benches are not freestanding and must be supported during this step.

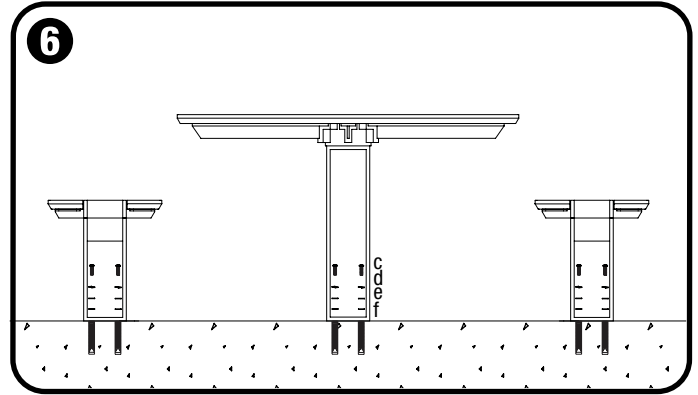

Attach benches and table

- Slide 1/2" stainless steel lock washer (d), 1/2" stainless steel flat washer (e), and 1/2" nylon flat washer (f) onto each 1/2"-13 x 1-1/2" tamper-resistant button head cap bolt (c).
- Insert bolts into mounting holes in table and benches and thread into anchors using 5/16" hex bit for tamper-resistant bolts.

NOTE: Table and benches are not freestanding and must be supported during this step.

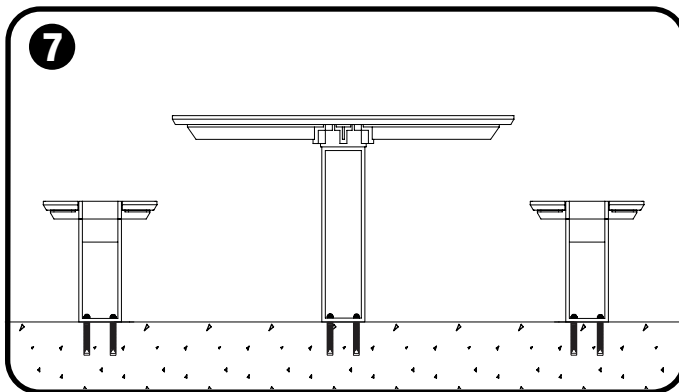

Tighten bolts

- Tighten bolts until snug.