

LIGHT COLUMN BOLLARD

SURFACE MOUNT WITH J-BOLTS INSTALLATION INSTRUCTIONS

MATERIALS INCLUDED	TOOLS NEEDED
 <p>a</p> <p>b c</p> <p>template (upon request)</p>	 <p>masking tape</p> <p>socket wrench</p> <p>3/4" socket</p> <p>strap wrench</p> <p>silicone RTV sealant (optional)</p>

STEP BY STEP FOR ALL STANDARD LIGHT COLUMN BOLLARDS

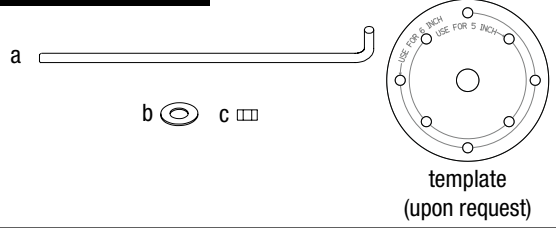
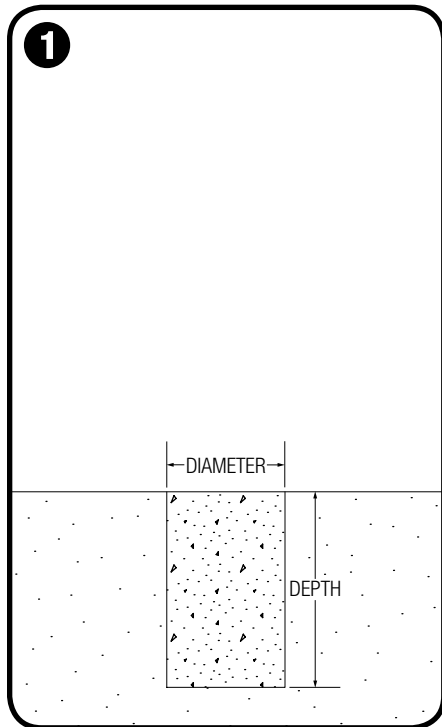

Pour concrete footer

- Mix and pour concrete footer according to concrete manufacturer's instructions.
- A sufficient footer size depends on frost and other conditions to be determined by the installer.
- A minimum of a 12" diameter x 20" deep footer is recommended for Series 500 bollards; minimum of a 13" diameter x 20" deep footer is recommended for Series 600 bollards.

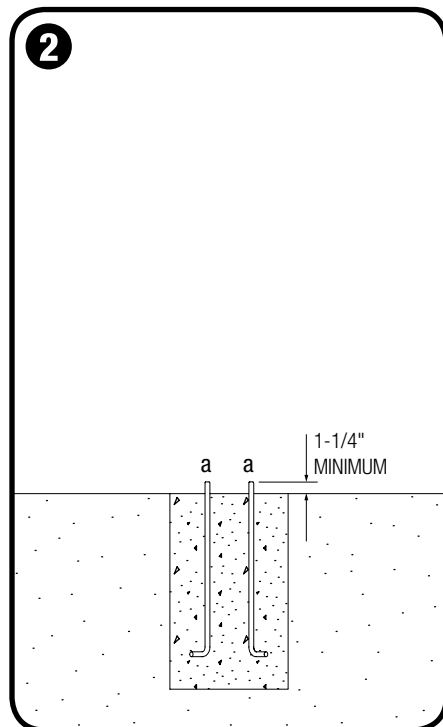

Insert J-bolt anchors

- Insert 1/2"-13 x 18" galvanized steel J-bolt anchors (a) into concrete.
- Use template (included) to position J-bolt anchors in proper locations. Tops of J-bolt anchors must be a minimum of 1-1/4" above concrete surface.
- Allow concrete to set completely, in accordance with concrete manufacturer's instructions, before moving to step 3.

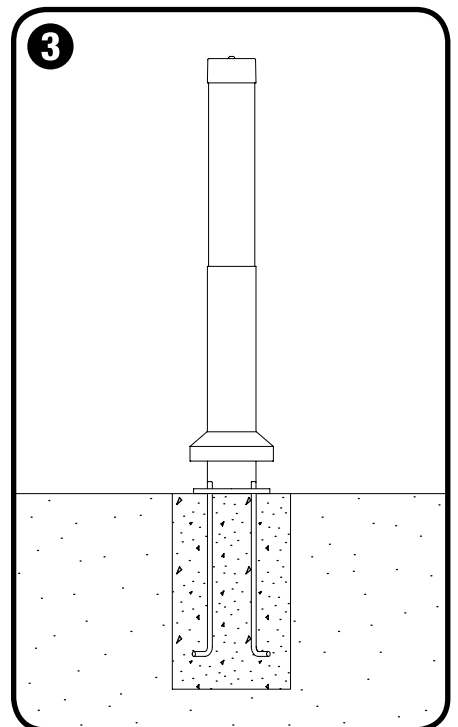

Slide bollard onto J-bolt anchors

- Slide bollard base plate over J-bolt anchors and lower bollard to concrete level.
- Carefully use masking tape to tape escutcheon cover further up the body until installation is complete.

LIGHT COLUMN BOLLARD

SURFACE MOUNT WITH J-BOLTS INSTALLATION INSTRUCTIONS

STEP BY STEP FOR ALL STANDARD LIGHT COLUMN BOLLARDS

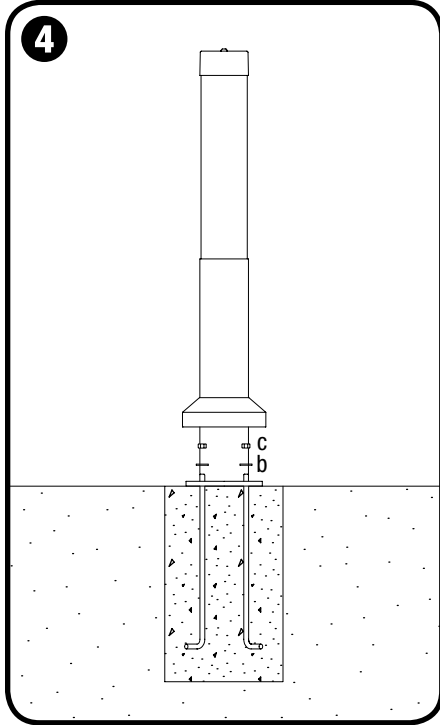

Attach bollard

- Slide 1/2" washer (b), then thread 1/2"-13 nut (c) onto each J-bolt anchor.

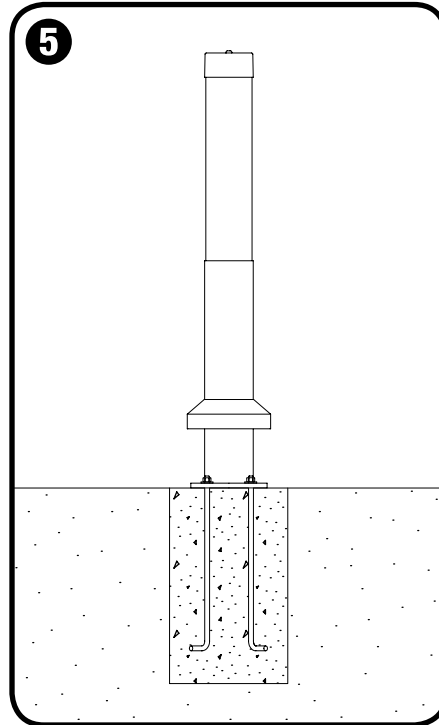

Tighten nuts

- Use 3/4" socket and socket wrench to tighten all nuts until snug.

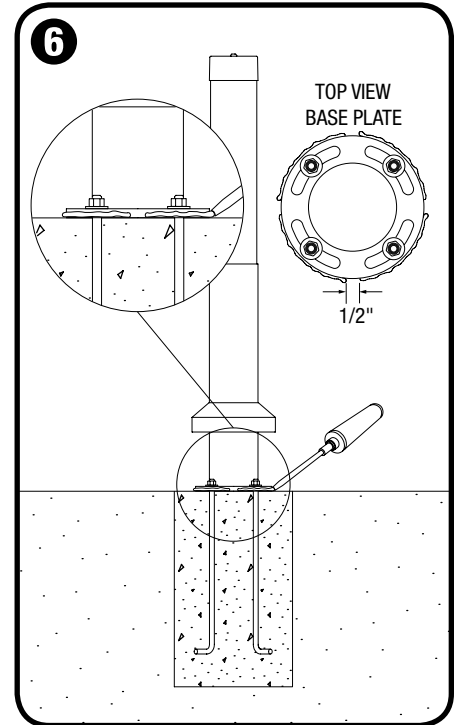

Attach escutcheon cover (optional)

- Apply a thick bead of silicone RTV sealant around the vertical edge of the base plate.
NOTE: Leave four 1/2" gaps to allow for water drainage.
- Lower escutcheon cover to ground level and wipe away any excess sealant.

LIGHT COLUMN BOLLARD

SURFACE MOUNT WITH J-BOLTS INSTALLATION INSTRUCTIONS

STEP BY STEP FOR ALL STANDARD LIGHT COLUMN BOLLARDS

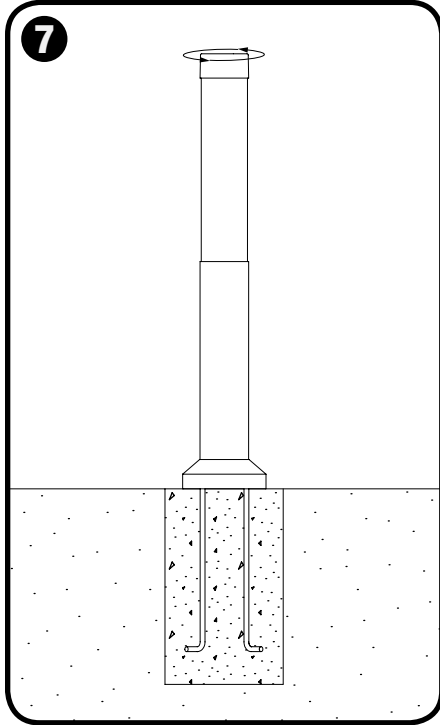

Remove top cap and lens

- Use strap wrench to unscrew stainless steel top cap by turning counterclockwise.
- Remove top cap and lens.

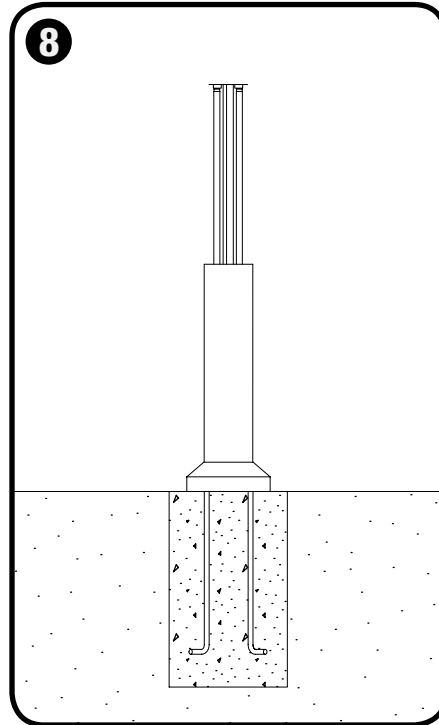

Insert lamps

- Insert or replace lamps.

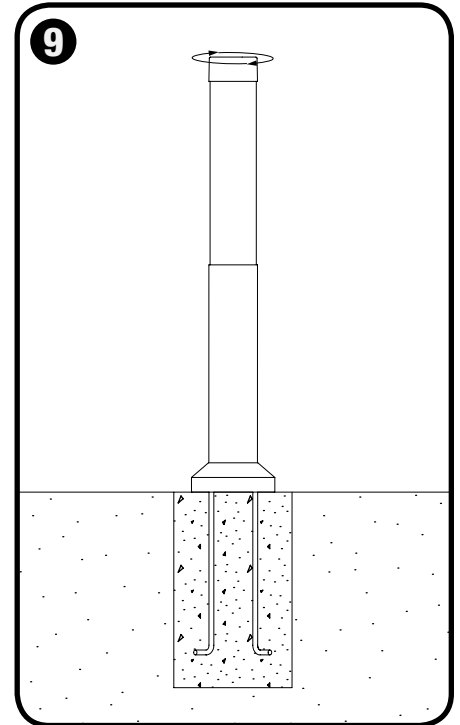

Replace lens and top cap

- Replace lens.
- Place stainless steel top cap on top of bollard and twist clockwise. Tighten with strap wrench.