

PACIFICA™ BENCH

SURFACE MOUNT INSTALLATION INSTRUCTIONS

MOUNTING KIT (SOLD SEPARATELY)

7/32" hex bit for
tamper-resistant bolts

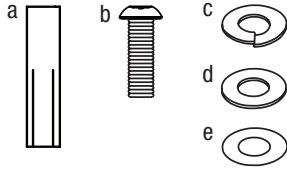

TOOLS NEEDED

pencil

3/16", 3/8" & 1/2" drill
bits for concrete

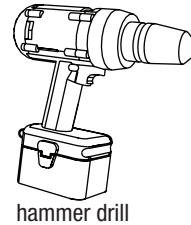

steel
wire brush

1/4" punch

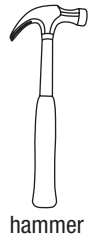

STEP BY STEP FOR ALL SURFACE MOUNTED PACIFICA BENCHES (SBPAC-8SL SHOWN)

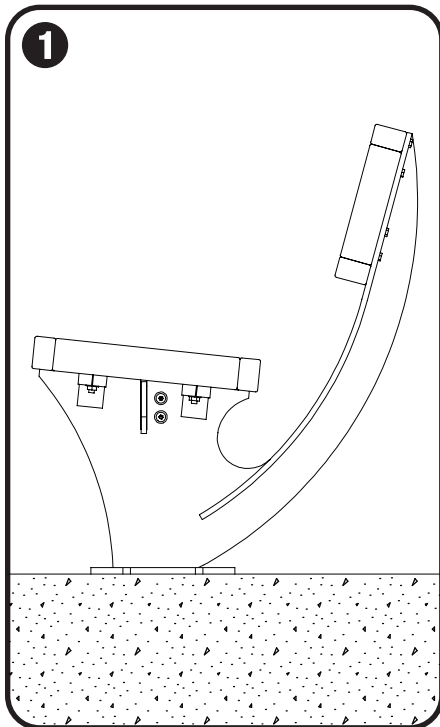

1 Mark hole locations

- Place bench in desired location. Mark center of each hole location with a pencil.

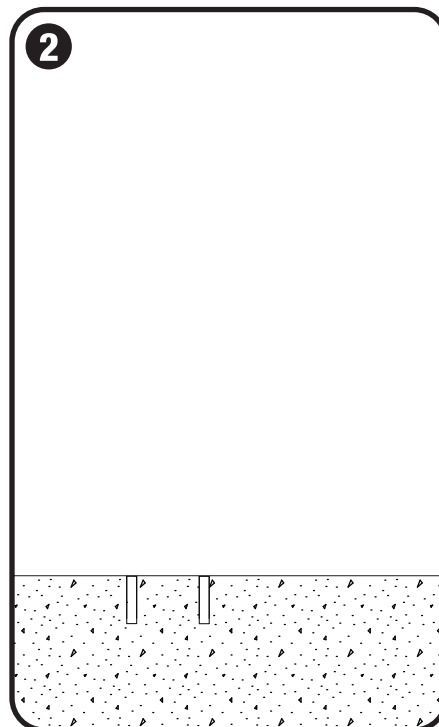

2 Drill holes

- Use hammer drill to drill 1-7/8" deep x 1/2" diameter anchor hole at each marked location using a 1/2" drill bit suitable for concrete drilling.

NOTE: Forms+Surfaces recommends starting holes with 3/16" diameter drill bit followed by 3/8" and finally 1/2" for maximum accuracy.

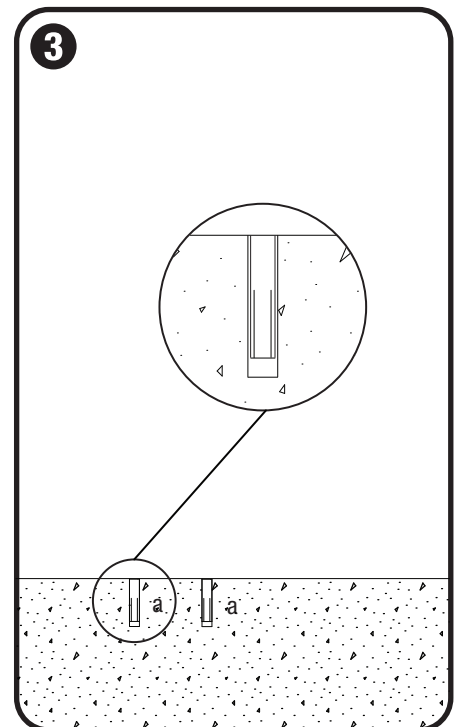

3 Insert & set anchors

- Use compressed air and steel wire brush to clean each anchor hole.
- Insert 3/8"-16 x 1-1/2" anchor (a) into each anchor hole and use hammer to tap anchor tops flush with ground level.
- Use 1/4" punch and hammer to set anchors by driving down the center of each anchor until it stops.

PACIFICA™ BENCH

SURFACE MOUNT INSTALLATION INSTRUCTIONS

STEP BY STEP FOR ALL SURFACE MOUNTED PACIFICA BENCHES (SBPAC-8SL SHOWN)

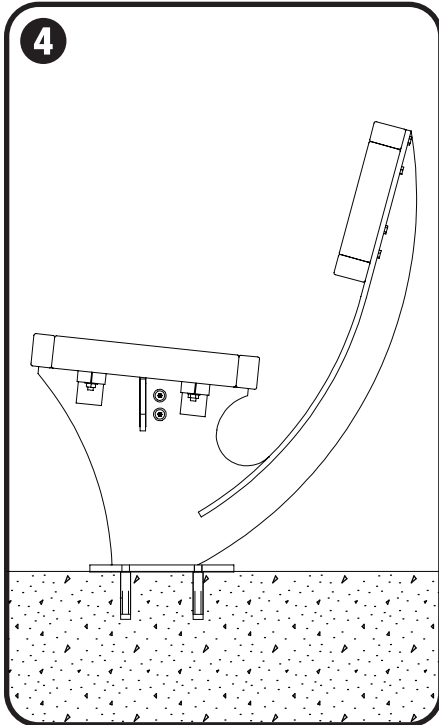

Position bench

- Position bench so that mounting holes line up with anchors.

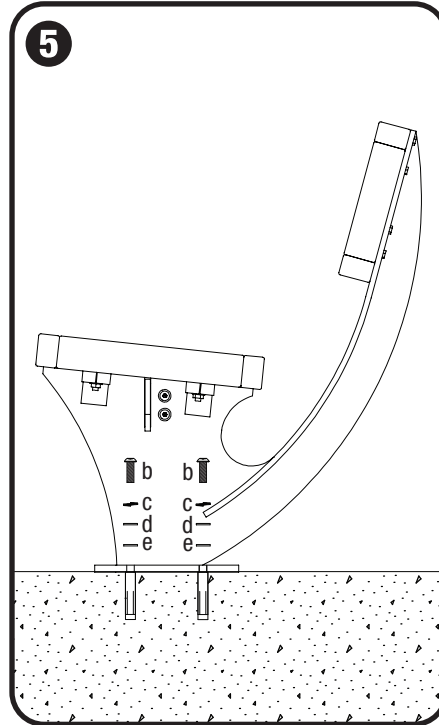

Attach bench

- Slide 3/8" stainless steel lock washer (c), then 3/8" stainless steel flat washer (d) and 3/8" nylon flat washer (e) onto each 3/8"-16 x 1" tamper-resistant button head cap bolt (b).
- Insert bolts into mounting holes in bench and thread into anchors using 7/32" hex bit for tamper-resistant bolts.

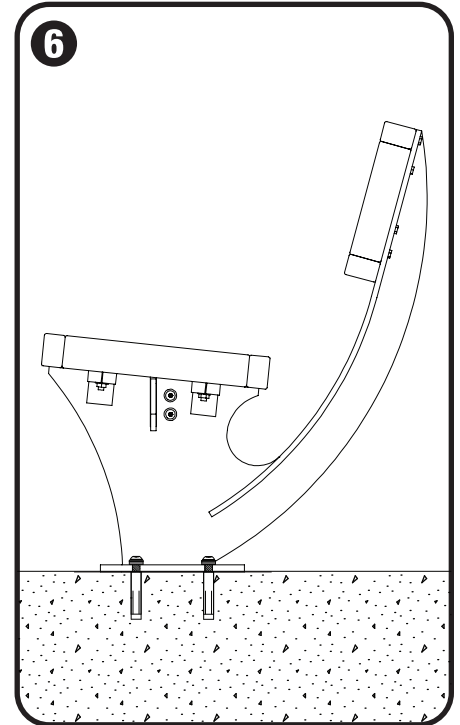

Tighten bolts

- Tighten bolts until snug.