











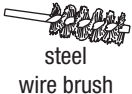





SOLERIS SUNSHADE

STANDALONE SURFACE MOUNT INSTALLATION INSTRUCTIONS

MATERIALS INCLUDED		TOOLS NEEDED	
	5/16" hex bit for tamper-resistant screws		
	7/32" hex bit for tamper-resistant screws		
			
			
			
			
			

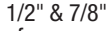
STEP BY STEP FOR ALL STANDALONE SOLERIS SUNSHADES

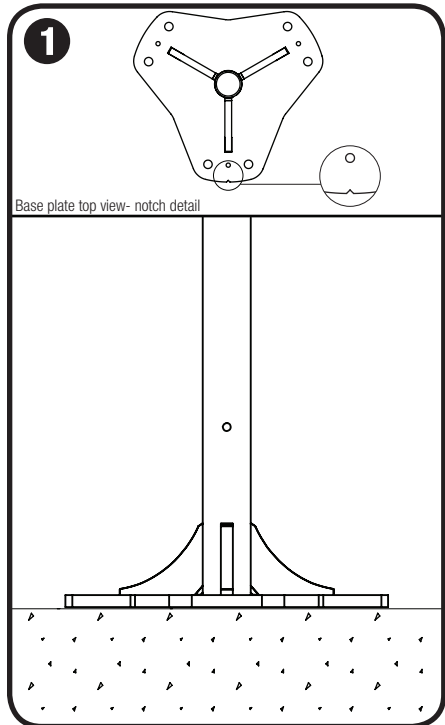

Mark hole locations

- Place the surface mount stand in desired location. Mark center of each hole location with a pencil. Mounting holes are located on the sunshade's base plate.
- To show multiple Soleris Sunshades in the same orientation, align the notch on the base plates (detail above) in the same direction.

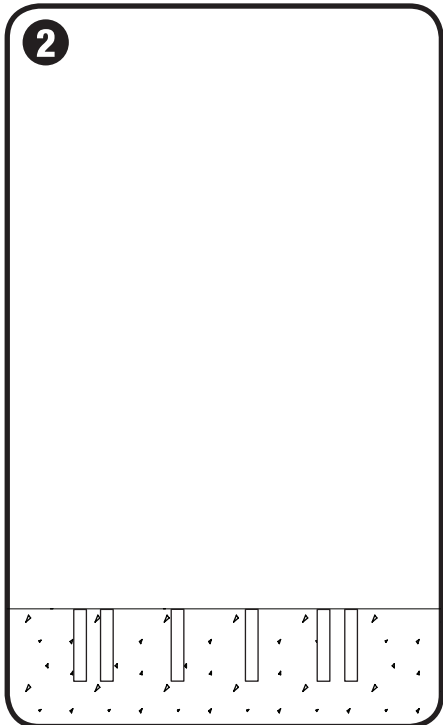

Drill holes

- Use hammer drill to drill 5" deep x 7/8" diameter anchor holes at each marked location using a 7/8" drill bit suitable for concrete drilling.

NOTE: Forms+Surfaces recommends starting holes with 1/4" diameter drill bit followed by 1/2" and finally 7/8" for maximum accuracy.

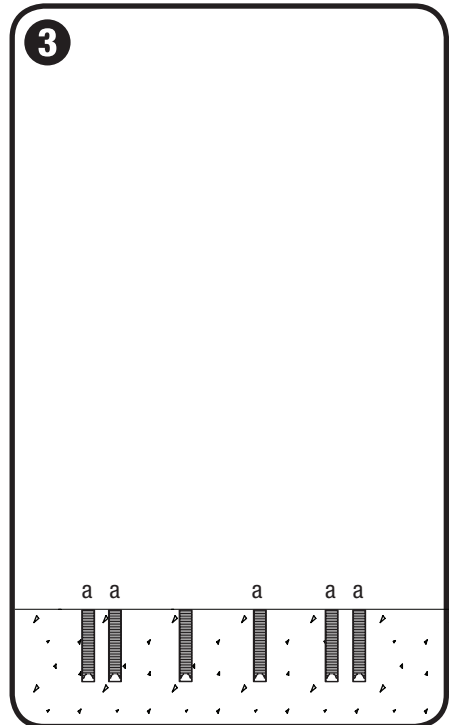

Fill holes & insert anchors

- Use compressed air and steel wire brush to clean each anchor hole in accordance with epoxy instructions.
- Use epoxy in epoxy gun to fill each anchor hole 5/8" of the hole depth in accordance with epoxy instructions.
- Insert 1/2"-13 x 5" epoxy anchor (a) into each anchor hole so anchor top is flush with ground. Allow proper curing time according to cure schedule on epoxy instructions before moving on to Step 4.

SOLERIS SUNSHADE

STANDALONE SURFACE MOUNT INSTALLATION INSTRUCTIONS

STEP BY STEP FOR ALL STANDALONE SOLERIS SUNSHADES

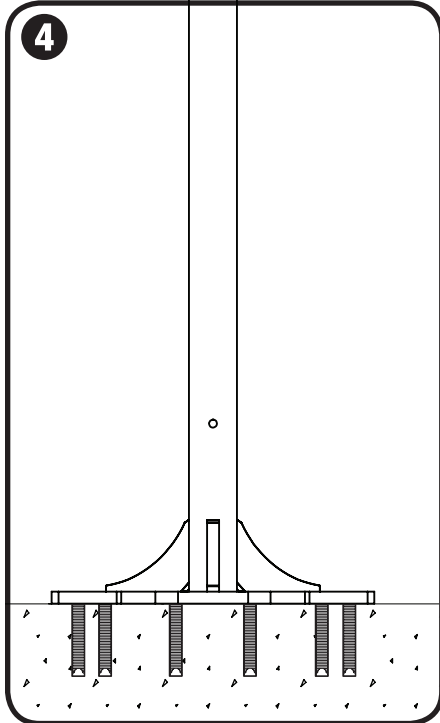

Position base plate

- Position base plate so that mounting holes line up with anchors.

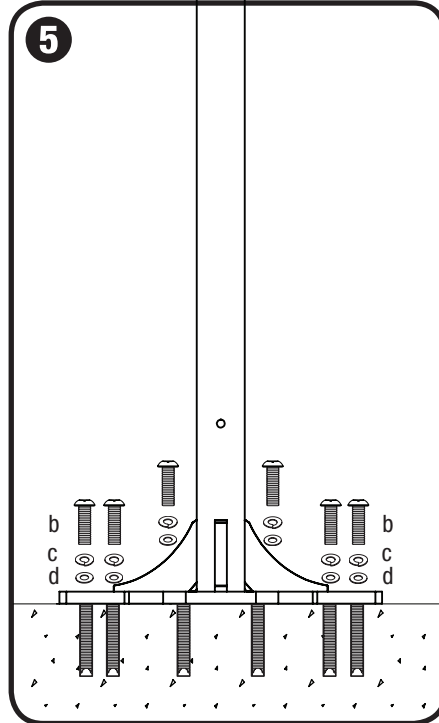

Attach base plate

- Slide 1/2" stainless steel lock washer (c), and 1/2" stainless steel flat washer (d), onto each 1/2"-13 x 1.5" tamper-resistant button head cap screw (b).
- Insert screws into mounting holes in the sunshade's base plate and thread into anchors using provided 5/16" hex bit for tamper-resistant screws.

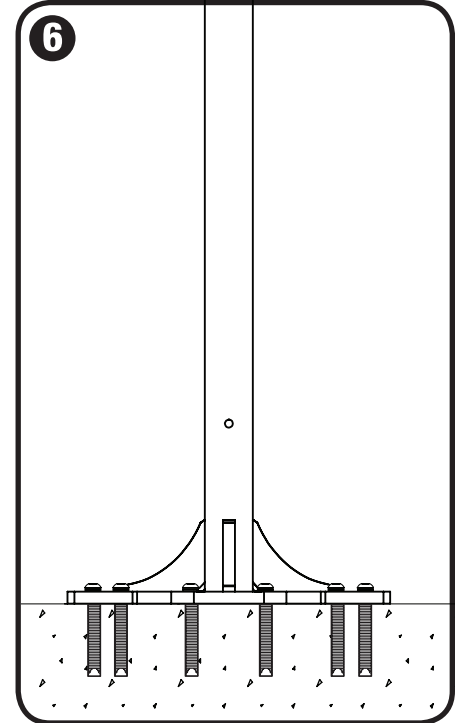

Tighten screws

- Tighten screws until snug.

SOLERIS SUNSHADE

STANDALONE SURFACE MOUNT INSTALLATION INSTRUCTIONS

STEP BY STEP FOR ALL STANDALONE SOLERIS SUNSHADES

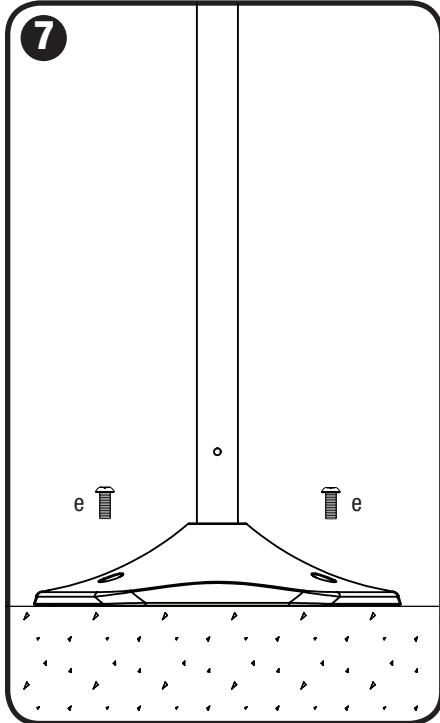

Attach escutcheon to base plate

- Position escutcheon so that the mounting holes line up with the base plate.
- Insert 3/8" -16 x 3/4" tamper-resistant button head cap screw (e) into mounting holes in the escutcheon and thread into holes using provided 7/32" hex bit for tamper-resistant screws.

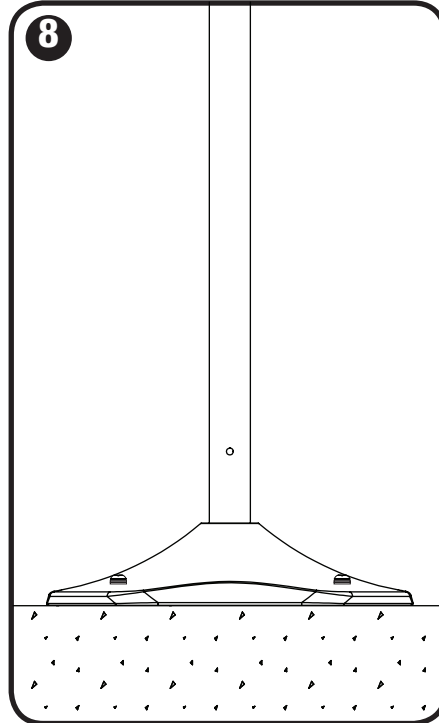

Tighten screws

- Tighten screws until snug.

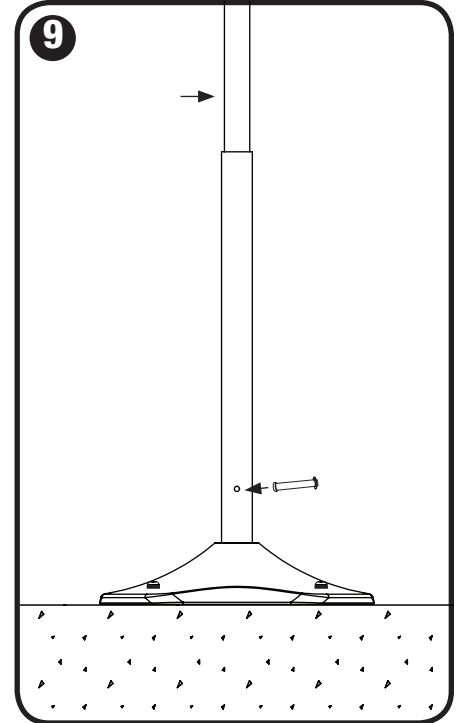

Place mounting pole in mounting pole sleeve and insert locking pin

- Place mounting pole into mounting pole sleeve.
- Line up the pre-drilled holes in the mounting pole and mounting pole sleeve, and insert the locking pin.

SOLERIS SUNSHADE

STANDALONE SURFACE MOUNT INSTALLATION INSTRUCTIONS

STEP BY STEP FOR ALL STANDALONE SOLERIS SUNSHADES

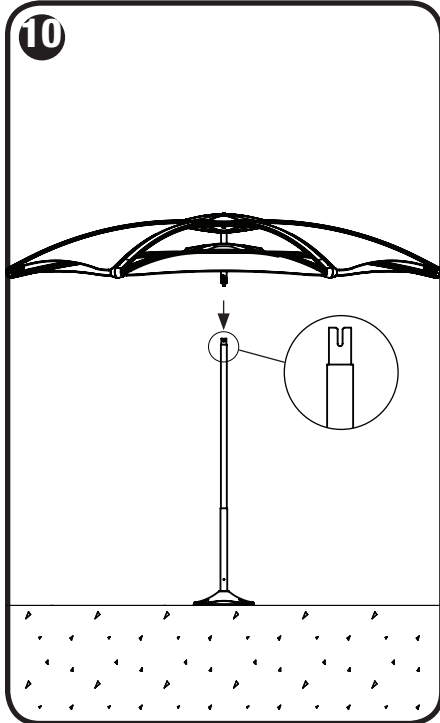

Slide sunshade assembly onto mounting pole

- Slide the tube in the center of the sunshade assembly onto the mounting pole, linking the two pieces together.

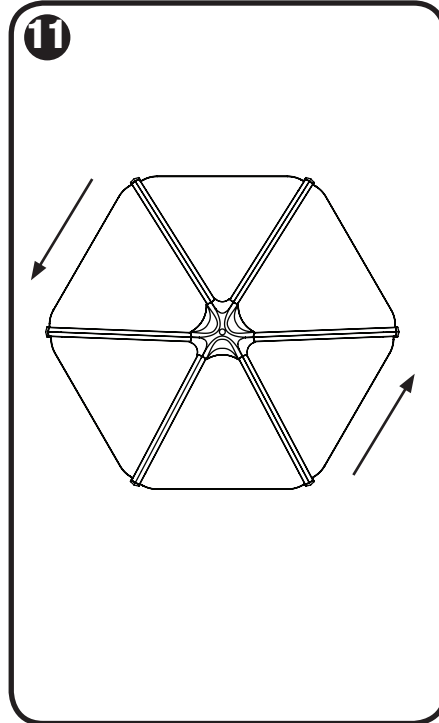

Rotate sunshade

- Rotate sunshade until it engages with pins.

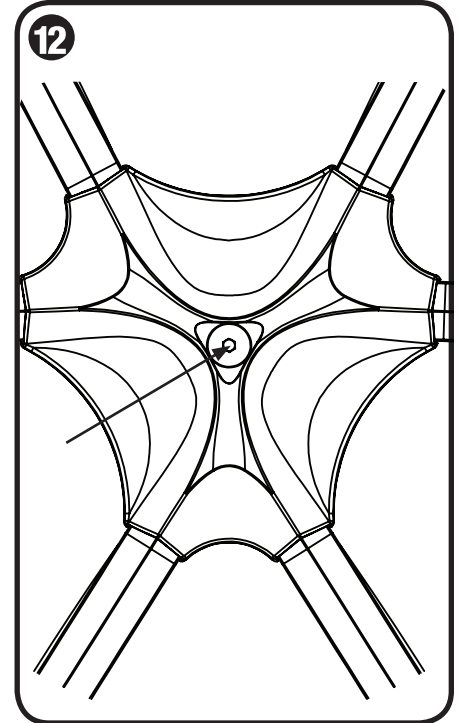

Tighten screw on top of sunshade

- Tighten screw on top of sunshade with ratchet until snug.