

SOLERIS™ SUNSHADE

SURFACE MOUNT WITH KNIGHT TABLE ENSEMBLE INSTALLATION INSTRUCTIONS

MATERIALS INCLUDED

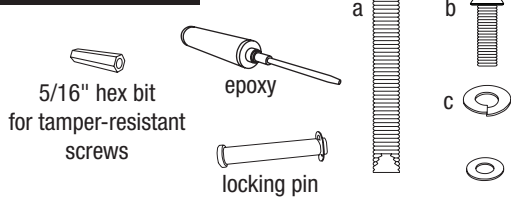

TOOLS NEEDED



STEP BY STEP FOR SOLERIS SUNSHADE USED WITH KNIGHT TABLE ENSEMBLE

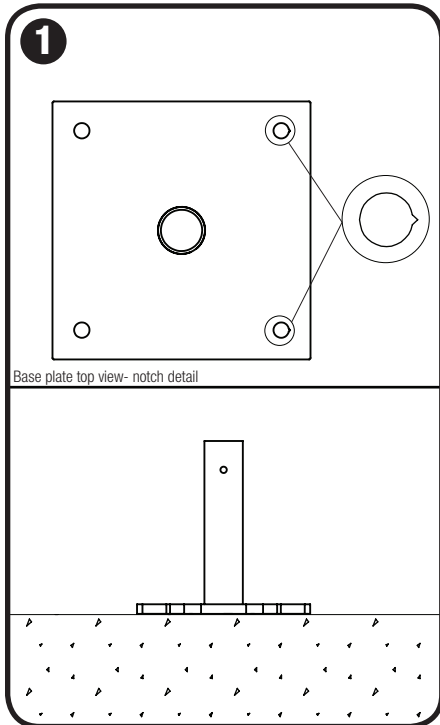

Mark hole locations

- Place the sunshade base plate in desired location. Mark center of each hole location with a pencil. Mounting holes are located on the sunshade's base plate.
- When determining base plate location ensure that notches on the base plate (detail above) point towards one of the Knight Table Ensemble seats for best sunshade coverage.
- To show multiple Soleris Sunshades in the same orientation, align the notch on the base plates in the same direction.

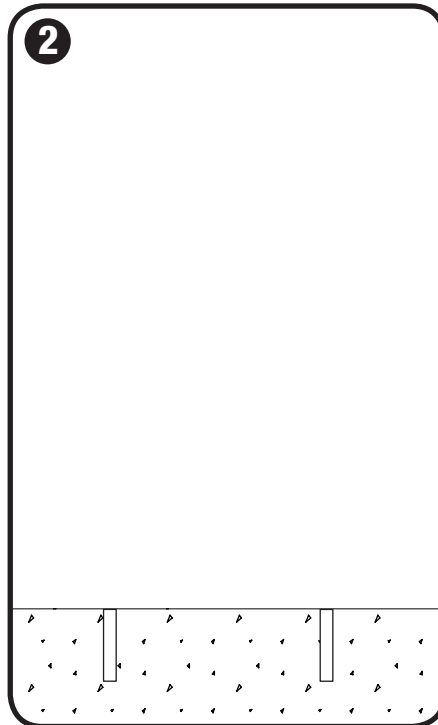

Drill holes

- Use hammer drill to drill 5" deep x 7/8" diameter anchor holes at each marked location using a 7/8" drill bit suitable for concrete drilling.

NOTE: Forms+Surfaces recommends starting holes with 1/4" diameter drill bit followed by 1/2" and finally 7/8" for maximum accuracy.

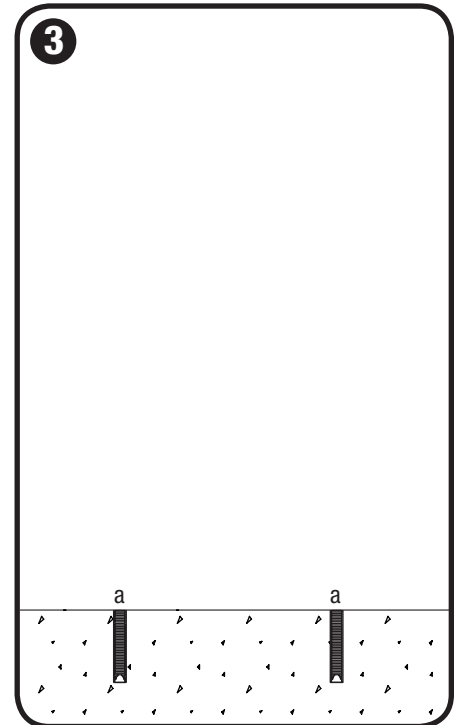

Fill holes & insert anchors

- Use compressed air and steel wire brush to clean each anchor hole in accordance with epoxy instructions.
- Use epoxy in epoxy gun to fill each anchor hole 5/8" of the hole depth in accordance with epoxy instructions.
- Insert 1/2"-13 x 5" epoxy anchor (a) into each anchor hole so anchor top is flush with ground. Allow proper curing time according to cure schedule on epoxy instructions before moving on to Step 4.

SOLERIS™ SUNSHADE

SURFACE MOUNT WITH KNIGHT TABLE ENSEMBLE INSTALLATION INSTRUCTIONS

STEP BY STEP FOR SOLERIS SUNSHADE USED WITH KNIGHT TABLE ENSEMBLE

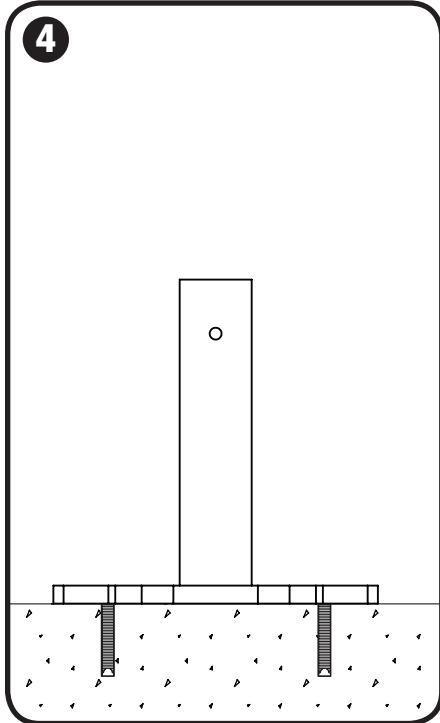

Position baseplate

- Position baseplate so that mounting holes line up with anchors.

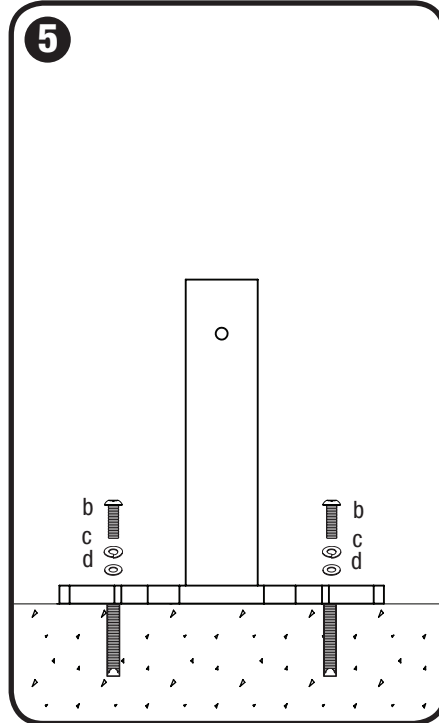

Attach baseplate

- Slide 1/2" stainless steel lock washer (c), and 1/2" stainless steel flat washer (d), onto each 1/2"-13 x 1.5" tamper-resistant button head cap screw (b).
- Insert screws into mounting holes in the sunshade's base plate and thread into anchors using provided 5/16" hex bit for tamper-resistant screws.

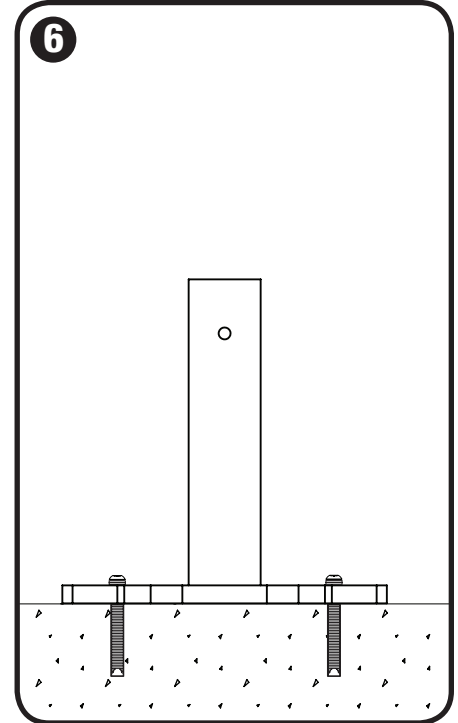

Tighten screws

- Tighten screws until snug.

SOLERIS™ SUNSHADE

SURFACE MOUNT WITH KNIGHT TABLE ENSEMBLE INSTALLATION INSTRUCTIONS

STEP BY STEP FOR SOLERIS SUNSHADE USED WITH KNIGHT TABLE ENSEMBLE (BACKED KNIGHT ENSEMBLE SHOWN)

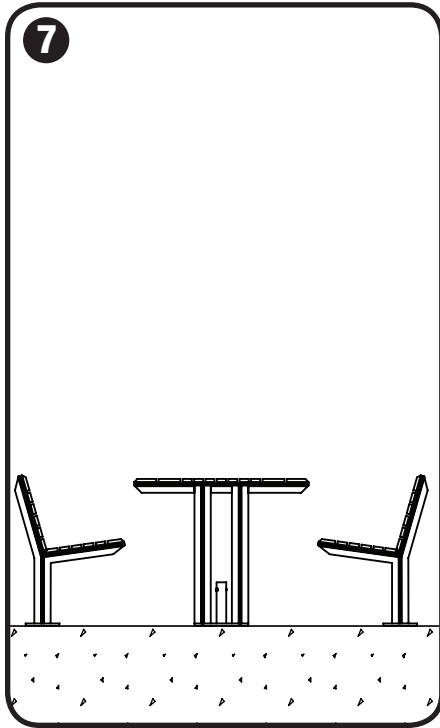

Place table ensemble on top of base plate

- Place table ensemble on top of the sunshade base plate at desired location to make sure that they are aligned.

NOTE: Table ensembles should be completely assembled to determine dimensions and proper positioning.

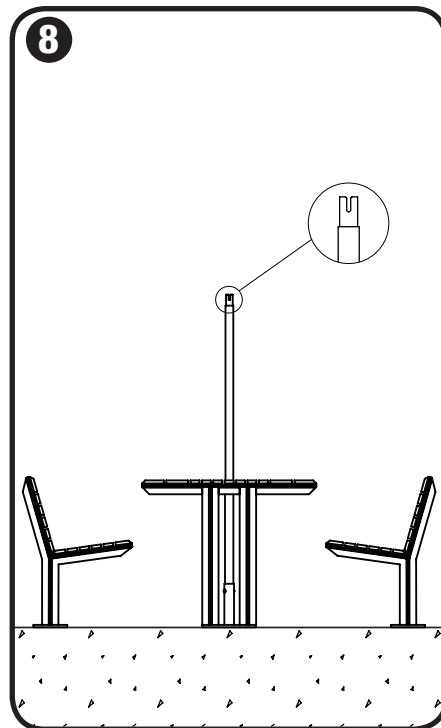

Put sunshade pole into the base plate

- Place sunshade pole, with notch facing up, through the table into the base plate to make sure that the sunshade and table are aligned.

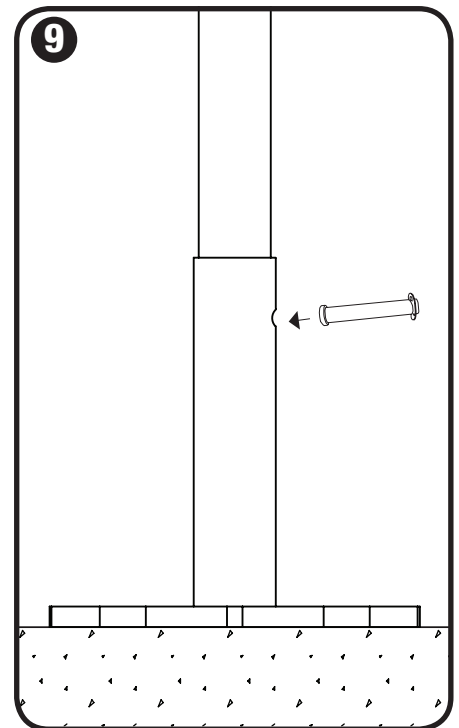

Insert locking pin to affix mounting pole to mounting assembly

- Line up the pre-drilled holes in the mounting pole and mounting pole sleeve, and insert the locking pin.

SOLERIS™ SUNSHADE

SURFACE MOUNT WITH KNIGHT TABLE ENSEMBLE INSTALLATION INSTRUCTIONS

STEP BY STEP FOR SOLERIS SUNSHADE USED WITH KNIGHT TABLE ENSEMBLE (BACKED KNIGHT ENSEMBLE SHOWN)

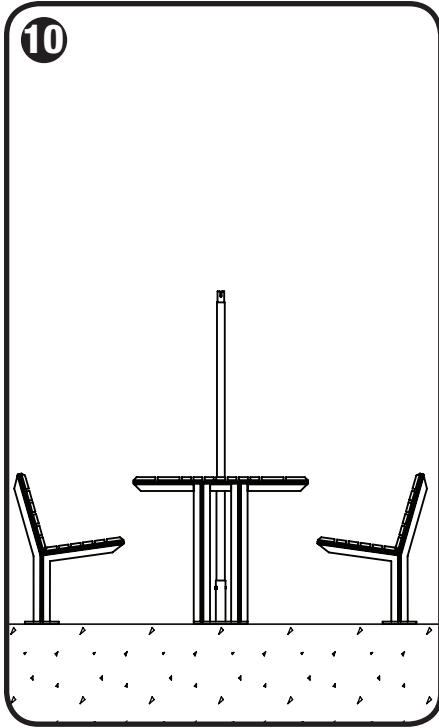

Continue Table Ensemble Surface Mount Installation

- Continue with the surface mount installation of the table ensemble. Please refer to the table surface mount installation instructions, provided separately.

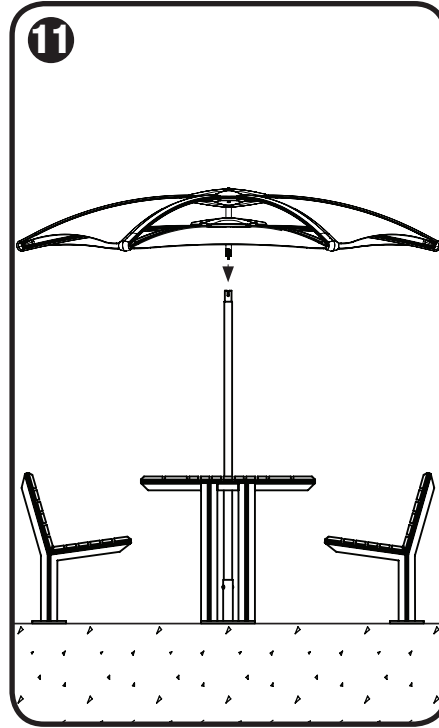

Slide sunshade assembly onto mounting pole

- Slide the tube in the center of the sunshade assembly onto the mounting pole, linking the two pieces together.

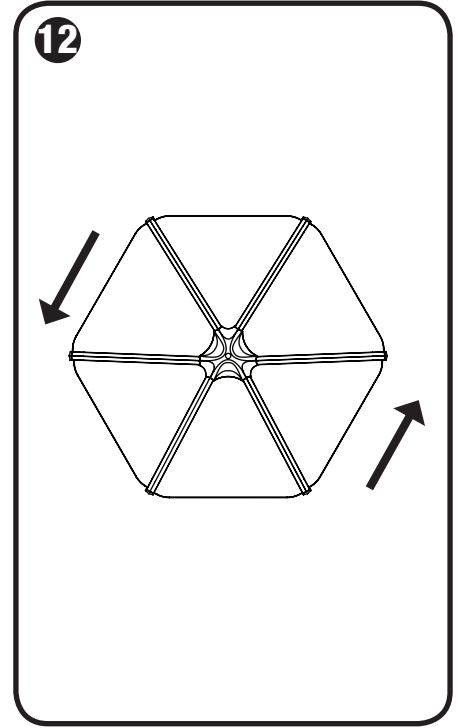

Rotate sunshade

- Rotate sunshade until it engages with pins.

SOLERIS™ SUNSHADE

SURFACE MOUNT WITH KNIGHT TABLE ENSEMBLE INSTALLATION INSTRUCTIONS

STEP BY STEP FOR SOLERIS SUNSHADE USED WITH KNIGHT TABLE ENSEMBLE

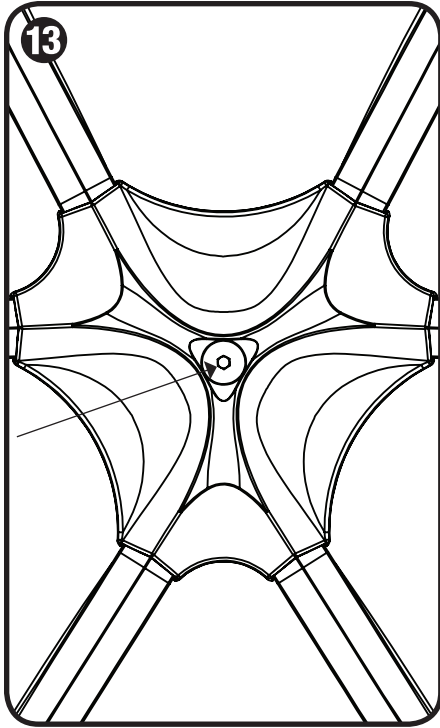

Tighten screw on top of sunshade

- Tighten screw on top of sunshade with ratchet until snug.