

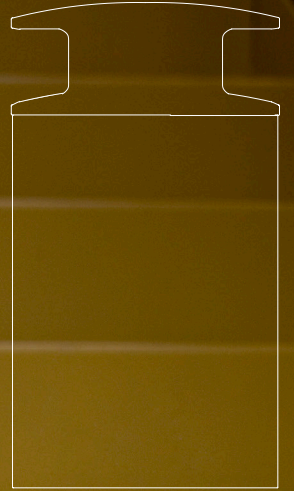

UNIVERSAL LITTER & RECYCLING RECEPTACLE

PRODUCT DATA





UNIVERSAL LITTER & RECYCLING RECEPTACLE

PRODUCT DATA

Blending unparalleled design flexibility with real-world functionality, **Universal Litter & Recycling Receptacles** offer the beauty and performance of stainless steel in a comprehensive range of sizes, configurations, and design options. Universal's highly adaptable format gives you the freedom to tailor receptacles to project-specific conditions. High-durability finishes and beautiful decorative patterns make it easy to create a striking visual statement. Top- and side-opening models, 12-36-gallon capacities, and single- and split-stream variations allow you to address a diversity of needs. At home indoors or out, Universal is a premier choice for airports, malls, universities, healthcare facilities, office buildings, and other public spaces.

MATERIAL & CONSTRUCTION DETAILS

INSTALLATION & MAINTENANCE

CONFIGURATIONS	LIDS	GRAPHICS	INSTALLATION
<ul style="list-style-type: none"> • Universal Receptacles are available in top- and side-opening configurations with 36-, 30-, 24-, and 12-gallon capacities. • Top-opening configurations have the same number of liners as lid openings. • With the exception of 12-gallon models, side-opening configurations can be specified with one full liner or two half liners with an internal baffle. 	<ul style="list-style-type: none"> • Lid material options vary per receptacle size, as described below and illustrated on pages 3-6. • 36- and 24-gallon receptacle lids are molded polyethylene. Top-opening lids with 10" diameter openings are also available in stainless steel for an upcharge. • 30-gallon receptacle lids are stainless steel. 	<ul style="list-style-type: none"> • Instructional graphics are available with a variety of standard messages that clearly indicate the use for each opening. • Graphics have white letters and symbols with black, blue, or green backgrounds. • Graphics are printed on the back of clear, lightly textured polycarbonate, protecting them from wear over time. • See page 7 for additional information. 	<ul style="list-style-type: none"> • Universal Receptacles may be used freestanding or surface mounted. • For surface mounting, stainless steel anchors and mounting bolts sold separately. • For freestanding, levelers are supplied for all polyethylene base receptacles.
BODY MATERIALS, FINISHES & PATTERNS	<ul style="list-style-type: none"> • 12-gallon receptacles are available in multiple variations: top-opening lids of molded polyethylene, or, for an upcharge, stainless steel; side-opening receptacles with dome lids of molded polyethylene; and side-opening receptacles with concealed ash lids of stainless steel. • Molded polyethylene lids have a UL94HB fire rating and are slate-colored with a light texture. • Stainless steel lids have a Satin finish. • Tether cables are available to connect receptacle lid to body. 	BASES	MAINTENANCE
<ul style="list-style-type: none"> • Stainless Steel with Sandstone, Seastone, Linen, Diamond, or Satin finish are available for all Universal Receptacles. • Three different body patterns are available for an upcharge; see page 7 for standard patterns. • Eco-Etch patterns are applied using an advanced photolithographic bead-blasting system. • Impression patterns are stamped, high relief designs. • Perforation patterns add a unique visual element. 	<ul style="list-style-type: none"> • Standard 1.5" high tapered bases are molded polyethylene with a UL94HB fire rating and are slate-colored with a light texture. 	<ul style="list-style-type: none"> • Polyethylene and metal surfaces can be cleaned as needed using a soft cloth or brush with warm water and a mild detergent. Avoid abrasive cleaners. • Use caution when cleaning over graphics. 	



UNIVERSAL LITTER & RECYCLING RECEPTACLE

PRODUCT DATA

36-GALLON NOMINAL DIMENSIONS

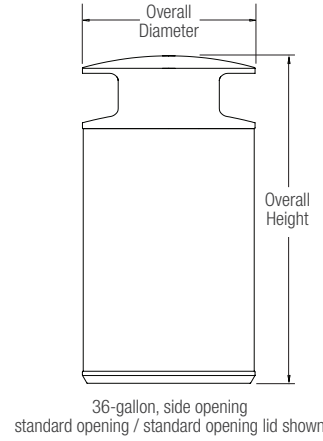
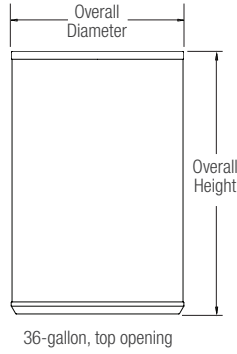

MODELS	OVERALL DIAMETER	OVERALL HEIGHT*	OVERALL WEIGHT*
36-gallon, top opening	21.4" (544 mm)	32.7" (831 mm)	49 lbs (22 kg)
36-gallon, side opening	21.5" (546 mm)	40.8" (1,036 mm)	52 lbs (24 kg)

36-GALLON, TOP-OPENING LIDS

CONFIGURATION	10" Diameter Opening*	Split-Stream
TOP VIEW		
SIDE VIEW		
OPENING(S)	10"	(2) 14.0" x 6.2"

*Top opening, 10" diameter opening lid is available in both polyethylene and stainless steel with Satin finish.

36-GALLON, SIDE-OPENING LIDS

CONFIGURATION	Standard Opening / Standard Opening	Standard Opening / Round Opening
TOP VIEW		
SIDE VIEW		
OPENINGS	(2) 17.1" x 6.0"	(1) 17.1" x 6.0" / (1) 7.6" x 6.5"



UNIVERSAL LITTER & RECYCLING RECEPTACLE

PRODUCT DATA

30-GALLON NOMINAL DIMENSIONS

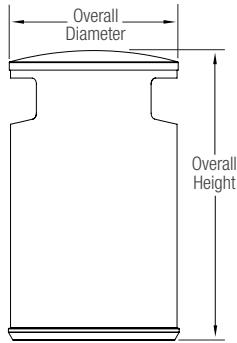

30-gallon, side opening, standard opening (front view)

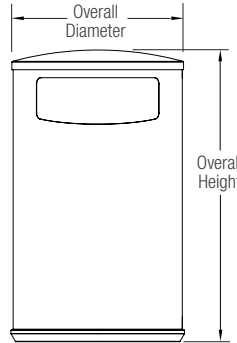

30-gallon, side opening, standard opening (right view)

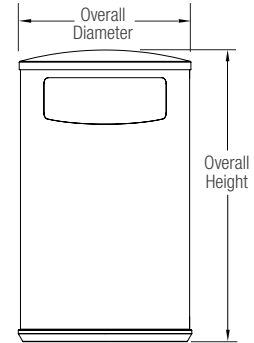

30-gallon, side opening, standard opening (left view)

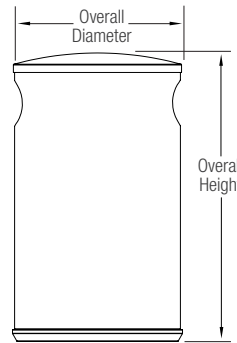

30-gallon, side opening, round opening (front view)

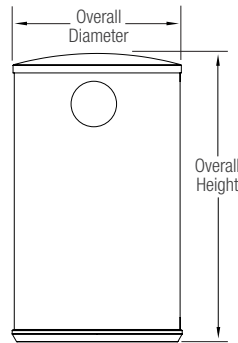

30-gallon, side opening, round opening (right view)

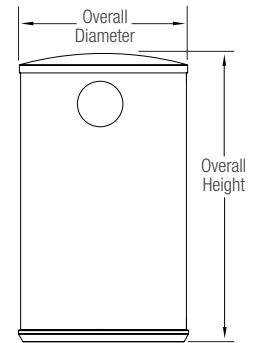

30-gallon, side opening, round opening (left view)

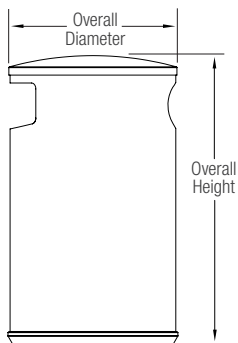

30-gallon, side opening, standard opening, round opening (side view)

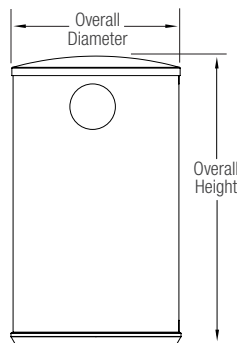

30-gallon, side opening, standard opening, round opening (right view)

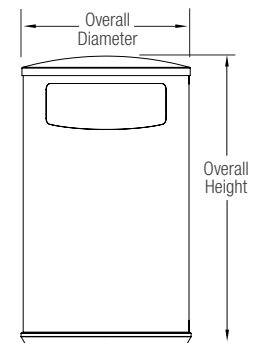

30-gallon, side opening, standard opening (left view)

MODEL	OVERALL DIAMETER	OVERALL HEIGHT*	OVERALL WEIGHT*
30-gallon, side opening	21.5" (546 mm)	37.5" (953 mm)	50 lbs (23 kg)



UNIVERSAL LITTER & RECYCLING RECEPTACLE

PRODUCT DATA

24-GALLON NOMINAL DIMENSIONS

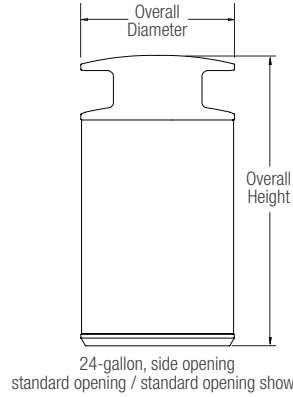
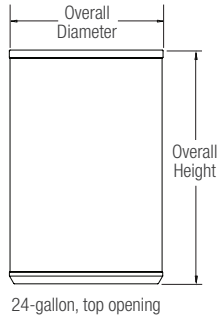

MODELS	OVERALL DIAMETER	OVERALL HEIGHT*	OVERALL WEIGHT*
24-gallon, top opening	19.4" (493 mm)	29.5" (749 mm)	42 lbs (19 kg)
24-gallon, side opening	19.4" (493 mm)	37.3" (947 mm)	45 lbs (20 kg)

24-GALLON, TOP-OPENING LIDS

CONFIGURATION	10" Diameter Opening*	Split-Stream
TOP VIEW		
SIDE VIEW		
OPENING(S)	10"	(2) 4.9" x 11.1"

*Top opening, 10" diameter opening lid is available in both polyethylene and stainless steel with Satin finish.

24-GALLON, SIDE-OPENING LIDS

CONFIGURATION	Standard Opening / Standard Opening	Standard Opening / Round Opening
TOP VIEW		
SIDE VIEW		
OPENINGS	(2) 15.9" x 5.3"	(1) 15.9" x 5.3" / (1) 7.3" x 6.3"



UNIVERSAL LITTER & RECYCLING RECEPTACLE

PRODUCT DATA

12-GALLON NOMINAL DIMENSIONS

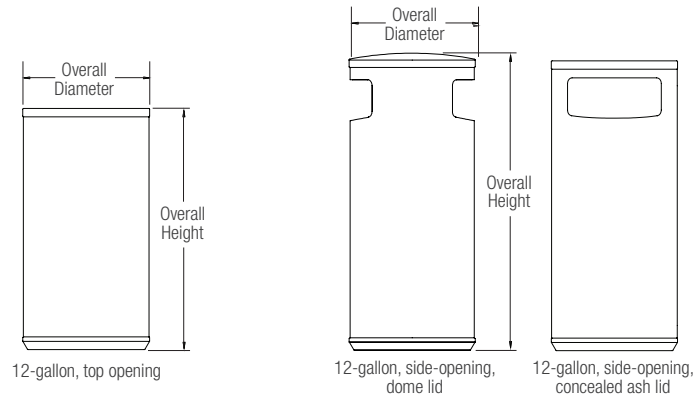

MODELS	OVERALL DIAMETER	OVERALL HEIGHT	OVERALL WEIGHT
12-gallon, top opening	15.1" (384 mm)	29.5" (749 mm)	25 lbs (11 kg)
12-gallon, side opening	15.1" (384 mm)	36.2" (919 mm) (35.5" concealed ash lid)	27 lbs (12 kg)

12-GALLON, TOP-OPENING LID

CONFIGURATION	7" Diameter Opening*
TOP VIEW	
SIDE VIEW	
OPENING(S)	7"

12-GALLON, SIDE-OPENING LIDS

CONFIGURATION	Dome	Concealed Ash**
TOP VIEW		
SIDE VIEW		
OPENINGS IN BODY (see top of page)	(2) 11.0" x 4.9"	(2) 11.0" x 4.9" (5" diameter ash opening in lid)

*Top opening, 7" diameter opening lid is available in both polyethylene and stainless steel with Satin finish.

**Concealed ash lid is available in stainless steel with Satin finish only.



UNIVERSAL LITTER & RECYCLING RECEPTACLE

PRODUCT DATA

STANDARD GRAPHICS

All graphics are available with black backgrounds. Recycling, bottles & cans, paper, and compost graphics are also available with blue or green backgrounds to clearly indicate recycling streams. All letters and symbols are white.

TOP-OPENING GRAPHICS



SIDE-OPENING GRAPHICS



BODY PATTERNS

The standard body patterns are shown in the 36-gallon, top-opening configuration. Eco-Etch patterns are shown with the etched areas in grey. Impression patterns are not available for 12-gallon, side-opening models.



Horizon Eco-Etch

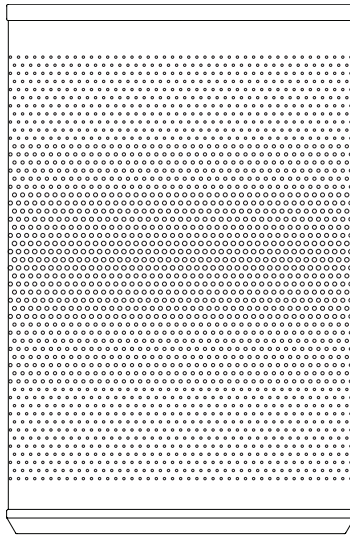

Fade Perforation

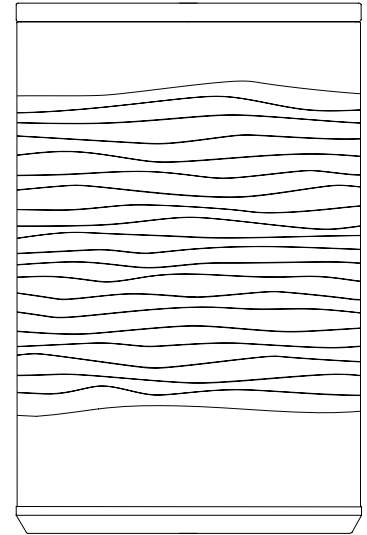

Dune Impression



UNIVERSAL LITTER & RECYCLING RECEPTACLE

PRODUCT DATA

ENVIRONMENTAL CONSIDERATIONS

- Please refer to the Universal Receptacle Environmental Data Sheet for detailed environmental impact information.
- Universal has a high recycled content.
- All components are fully recyclable.
- Low maintenance.

MODEL NUMBERS AND DESCRIPTIONS

MODEL	DESCRIPTION
SLUNN-36T10	Universal Receptacle, 36-gallon, top opening, 10" diameter opening; polyethylene or stainless steel lid
SLUNN-36TS	Universal Receptacle, 36-gallon, top opening, split-stream, polyethylene lid
SLUNN-36SSS	Universal Receptacle, 36-gallon, side opening, standard opening / standard opening, polyethylene lid
SLUNN-36SSR	Universal Receptacle, 36-gallon, side opening, standard opening / round opening, polyethylene lid
SLUNN-30SRR	Universal Receptacle, 30-gallon, side opening, round opening / round opening, stainless steel lid
SLUNN-30SSS	Universal Receptacle, 30-gallon, side opening, standard opening / standard opening, stainless steel lid
SLUNN-30SSR	Universal Receptacle, 30-gallon, side opening, standard opening / round opening, stainless steel lid
SLUNN-24T10	Universal Receptacle, 24-gallon, top opening, 10" diameter opening; polyethylene or stainless steel lid
SLUNN-24TSS	Universal Receptacle, 24-gallon, top opening, split-stream, polyethylene lid
SLUNN-24SSS	Universal Receptacle, 24-gallon, side opening, standard opening / standard opening, polyethylene lid
SLUNN-24SSR	Universal Receptacle, 24-gallon, side opening, standard opening / round opening, polyethylene lid
SLUNN-12T7	Universal Receptacle, 12-gallon, top opening, 7" diameter opening; polyethylene or stainless steel lid
SLUNN-12SD	Universal Receptacle, 12-gallon, side opening, polyethylene dome lid
SLUNN-12SA	Universal Receptacle, 12-gallon, side opening, stainless steel concealed ash lid

PRODUCT OPTIONS

The following options are available for an upcharge

Upgrade from one full liner to two half liners and internal baffle for side opening receptacles	Add standard body pattern
Upgrade from polyethylene lid to stainless steel lid where applicable	Add tether cable to connect lid to receptacle body

LEAD TIME: 6 to 8 weeks. Shorter lead times may be available upon request. Please contact us to discuss your specific timing requirements.

PRICING: Please contact us at **800.451.0410** or **sales@forms-surfaces.com**. At Forms+Surfaces, we design, manufacture and sell our products directly to you. Our sales team is available to assist you with questions about our products, requests for quotes, and orders. Territory Managers are located worldwide to assist with the front-end specification and quoting process, and our in-house Project Sales Coordinators follow your project through from the time you place an order to shipment.

TO ORDER SPECIFY: Quantity, model, lid material, lid graphics, body material and finish, body pattern, base material, freestanding or surface mount, bag straps, drain holes, and lid tether. Quote/Order Forms are available on our website to lead you through the specification process in a simple checkbox format.

NOTE: Because different computers will render colors and textures differently, actual colors and finishes may vary slightly from those shown here.