

PROJECT NAME: \_\_\_\_\_

DATE: \_\_\_\_\_

JOB LOCATION: \_\_\_\_\_

COMPANY: \_\_\_\_\_

PLEASE USE ADOBE READER OR ADOBE ACROBAT TO FILL OUT AND SAVE FORM. USING OTHER PROGRAMS COULD RESULT IN UNSAVED DATA.

**MODEL**

The drawings below will serve as a guide for planning your order. We will contact you to confirm all information, including configuration layouts and module quantities.

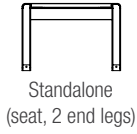

Quantity:  
 \_\_\_\_\_ 2-foot  
 \_\_\_\_\_ 4-foot  
 \_\_\_\_\_ 6-foot  
 \_\_\_\_\_ 8-foot

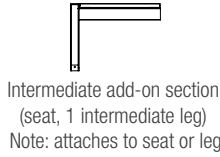

Intermediate add-on section  
 (seat, 1 intermediate leg)  
 Note: attaches to seat or leg

Quantity:  
 \_\_\_\_\_ 2-foot; attaches to leg  
 \_\_\_\_\_ 4-foot; attaches to leg  
 \_\_\_\_\_ 6-foot; attaches to leg  
 \_\_\_\_\_ 8-foot; attaches to leg

Quantity:  
 \_\_\_\_\_ 2-foot; attaches to seat  
 \_\_\_\_\_ 4-foot; attaches to seat  
 \_\_\_\_\_ 6-foot; attaches to seat

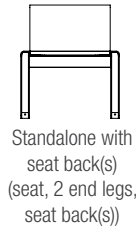

Standalone with seat back(s)  
 (seat, 2 end legs, seat back(s))

Quantity:  
 \_\_\_\_\_ 2-foot, one seat back  
 \_\_\_\_\_ 4-foot, two seat backs  
 \_\_\_\_\_ 6-foot, three seat backs  
 \_\_\_\_\_ 8-foot, four seat backs

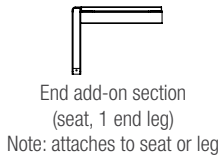

End add-on section  
 (seat, 1 end leg)  
 Note: attaches to seat or leg

Quantity:  
 \_\_\_\_\_ 2-foot; attaches to leg  
 \_\_\_\_\_ 4-foot; attaches to leg  
 \_\_\_\_\_ 6-foot; attaches to leg  
 \_\_\_\_\_ 8-foot; attaches to leg

Quantity:  
 \_\_\_\_\_ 2-foot; attaches to seat  
 \_\_\_\_\_ 4-foot; attaches to seat  
 \_\_\_\_\_ 6-foot; attaches to seat

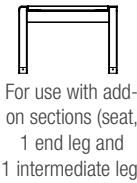

For use with add-on sections (seat, 1 end leg and 1 intermediate leg)

Quantity:  
 \_\_\_\_\_ 2-foot  
 \_\_\_\_\_ 4-foot  
 \_\_\_\_\_ 6-foot  
 \_\_\_\_\_ 8-foot

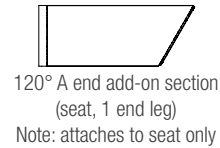

120° A end add-on section  
 (seat, 1 end leg)  
 Note: attaches to seat only

Quantity: \_\_\_\_\_

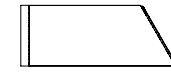

120° B end add-on section  
 (seat, 1 end leg)  
 Note: attaches to seat only

Quantity: \_\_\_\_\_

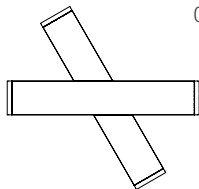

Oblique Configuration  
 (seat, 4 end legs)

Quantity: \_\_\_\_\_

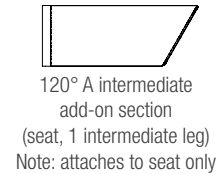

120° A intermediate add-on section  
 (seat, 1 intermediate leg)  
 Note: attaches to seat only

Quantity: \_\_\_\_\_

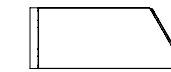

120° B intermediate add-on section  
 (seat, 1 intermediate leg)  
 Note: attaches to seat only

Quantity: \_\_\_\_\_

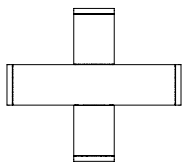

Cross Configuration  
 (seat, 4 end legs)

Quantity: \_\_\_\_\_

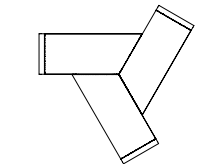

Tri-Hub Configuration,  
 120° A (seat, 3 end legs)

Quantity: \_\_\_\_\_

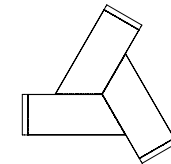

Tri-Hub Configuration,  
 120° B (seat, 3 end legs)

Quantity: \_\_\_\_\_

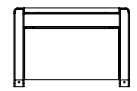

Standalone planter  
 (planter, 2 end legs)

Quantity: \_\_\_\_\_

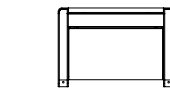

For use with add-on sections  
 (planter, 1 end leg and 1 intermediate leg)

Quantity: \_\_\_\_\_

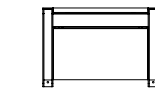

For use with add-on sections  
 (planter, 2 intermediate legs)

Quantity: \_\_\_\_\_

OPTIONS

FIG 1: VECTOR BENCH, 3-FOOT, BACKED, 4 SEAT DIVIDERS

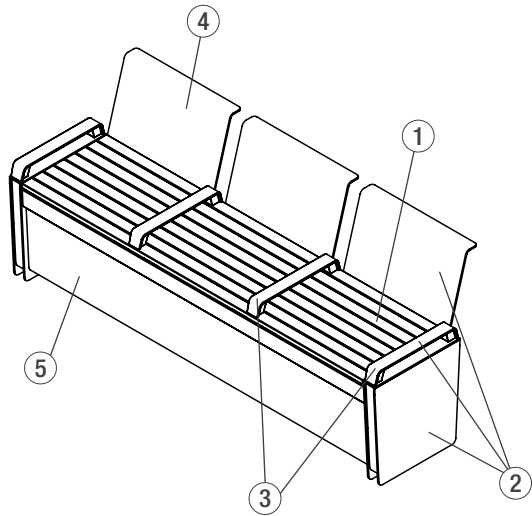
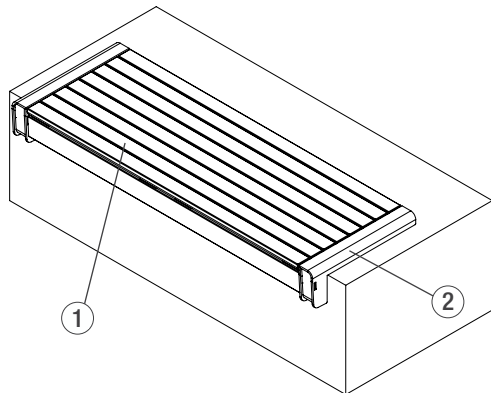

FIG 2: VECTOR WALL-TOP MOUNT BENCH, 2-FOOT, BACKLESS



1

Seat Material and Finish Options

Please select **one** material and applicable options.

FSC® 100% Cumaru Hardwood Slats (FSC License Code: FSC-C004453)

Aluminum Slats

Please select **one** powdercoat color option below.

Standard Texture / Gloss from Forms+Surfaces Powdercoat Chart

- |   |   |
|---|---|
| <input type="checkbox"/> Aluminum Texture             | <input type="checkbox"/> Dark Grey Metallic Texture |
| <input type="checkbox"/> Argento Texture              | <input type="checkbox"/> Evergreen Texture          |
| <input type="checkbox"/> Black Gloss                  | <input type="checkbox"/> Ink Blue Texture           |
| <input type="checkbox"/> Black Texture                | <input type="checkbox"/> Silver Texture             |
| <input type="checkbox"/> Blue Texture                 | <input type="checkbox"/> Slate Gloss                |
| <input type="checkbox"/> Bright Silver Gloss          | <input type="checkbox"/> Slate Texture              |
| <input type="checkbox"/> Cream Texture                | <input type="checkbox"/> White Texture              |
| <input type="checkbox"/> Dark Bronze Metallic Texture |   |

Premium Texture from Forms+Surfaces Powdercoat Chart  
(add \$200 per color/per order)

- |  |   |
|--|---|
| <input type="checkbox"/> Azure Texture | <input type="checkbox"/> Dark Corten Texture  |
| <input type="checkbox"/> Lime Texture  | <input type="checkbox"/> Light Corten Texture |

Custom RAL Powdercoat Color  
(please call for pricing information)

RAL Color: \_\_\_\_\_

2

Frame Powdercoat Color

Please select **one** powdercoat color option below.

NOTE: Due to the inherent nature of metal castings, gloss powdercoats are not offered for cast components.

Standard Texture from Forms+Surfaces Powdercoat Chart

- |   |   |
|---|---|
| <input type="checkbox"/> Aluminum Texture             | <input type="checkbox"/> Dark Grey Metallic Texture |
| <input type="checkbox"/> Argento Texture              | <input type="checkbox"/> Evergreen Texture          |
| <input type="checkbox"/> Black Texture                | <input type="checkbox"/> Ink Blue Texture           |
| <input type="checkbox"/> Blue Texture                 | <input type="checkbox"/> Silver Texture             |
| <input type="checkbox"/> Cream Texture                | <input type="checkbox"/> Slate Texture              |
| <input type="checkbox"/> Dark Bronze Metallic Texture | <input type="checkbox"/> White Texture              |

Premium Texture from Forms+Surfaces Powdercoat Chart  
(add \$200 per color/per order)

- |   |
|---|
| <input type="checkbox"/> Azure Texture        |
| <input type="checkbox"/> Lime Texture         |
| <input type="checkbox"/> Dark Corten Texture  |
| <input type="checkbox"/> Light Corten Texture |

Custom RAL Powdercoat color  
(please call for pricing information)

RAL Color: \_\_\_\_\_

3

Seat Divider Options

Please select **all** seat divider options that apply below.

- No seat divider
- One intermediate seat divider per 2-foot bench section  
Quantity \_\_\_\_\_ (Add \$75 per intermediate seat divider)
- End seat divider(s)  
Quantity \_\_\_\_\_ (Add \$75 per end seat divider)  
Placement Notes: \_\_\_\_\_  
\_\_\_\_\_

4

Seat Backs

Please select **one** seat back option below. Please note that seat backs cannot be placed at all connection points

- No seat back
- One seat back per 2-foot bench section  
Quantity \_\_\_\_\_ (Add \$175 per seat back)  
Placement Notes: \_\_\_\_\_  
\_\_\_\_\_  
\_\_\_\_\_

LED Accent Light

Please select **one** accent light option below.

- No LED accent light
- LED accent light
 

2-foot bench Quantity _____ 4-foot bench Quantity _____ 6-foot bench Quantity _____ 8-foot bench Quantity _____ 120° A bench Quantity _____ 120° B bench Quantity _____ Notes: _____ _____	LED color temperature (please select <b>one</b> LED option below) <input type="checkbox"/> 3000K <input type="checkbox"/> 4000K
---	--

Mounting Options

Please select **one** mounting option below.

- Surface mount**  
(required for configurations with seat backs or accent lighting)
- Freestanding**
- Wall-top\***  
\*Not all options are available for wall-top mounting, contact us to discuss your project's specific requirements

5

**Side Panel Options**

*Note: two side panels are required for each planter module; benches can accommodate one or two side panels.*

**No Side Panels**

**VividGlass Side Panel**

- 2-foot bench  
Quantity \_\_\_\_\_
- 4-foot bench  
Quantity \_\_\_\_\_
- 6-foot bench  
Quantity \_\_\_\_\_
- 8-foot bench  
Quantity \_\_\_\_\_

- 120° A bench  
Quantity \_\_\_\_\_
- 120° B bench  
Quantity \_\_\_\_\_
- Planter  
Quantity \_\_\_\_\_

**Standard Glass Pattern Options**

*(please select **one** standard pattern below)*

- Briar pattern in Mint
- Briar pattern in White
- Thicket pattern in Olive
- Thicket pattern in White
- Current pattern (horizontal) in White
- Current pattern (vertical) in Spring

**Stainless Steel Side Panel**

- 2-foot bench  
Quantity \_\_\_\_\_
- 4-foot bench  
Quantity \_\_\_\_\_
- 6-foot bench  
Quantity \_\_\_\_\_
- 8-foot bench  
Quantity \_\_\_\_\_

- 120° A bench  
Quantity \_\_\_\_\_
- 120° B bench  
Quantity \_\_\_\_\_
- Planter  
Quantity \_\_\_\_\_

**Stainless Steel Finish Options**

*(please select **one** standard finish below)*

- Sandstone
- Diamond
- Satin

**Standard Texture/ Gloss from Forms+Surfaces Powdercoat Chart**  
*(add \$50 per panel)*

- |   |   |
|---|---|
| <input type="checkbox"/> Aluminum Texture             | <input type="checkbox"/> Dark Grey Metallic Texture |
| <input type="checkbox"/> Argento Texture              | <input type="checkbox"/> Evergreen Texture          |
| <input type="checkbox"/> Black Gloss                  | <input type="checkbox"/> Ink Blue Texture           |
| <input type="checkbox"/> Black Texture                | <input type="checkbox"/> Silver Texture             |
| <input type="checkbox"/> Blue Texture                 | <input type="checkbox"/> Slate Gloss                |
| <input type="checkbox"/> Bright Silver Gloss          | <input type="checkbox"/> Slate Texture              |
| <input type="checkbox"/> Cream Texture                | <input type="checkbox"/> White Texture\             |
| <input type="checkbox"/> Dark Bronze Metallic Texture |   |

**Premium Texture from Forms+Surfaces Powdercoat Chart**  
*(add \$200 per color/per order)*

- Azure Texture
- Lime Texture
- Dark Corten Texture
- Light Corten Texture

**Custom RAL Powdercoat Color**  
*(please call for pricing information)*

RAL Color: \_\_\_\_\_

**Stainless Steel Perforation Options**  
*(add \$50 per panel)*

- |                                     |                                   |
|-------------------------------------|-----------------------------------|
| <input type="checkbox"/> No Pattern | <input type="checkbox"/> Rainfall |
| <input type="checkbox"/> Code       | <input type="checkbox"/> Gust     |
| <input type="checkbox"/> Data       |                                   |

**NOTES**

---

---

---

Please send completed forms to [sales@forms-surfaces.com](mailto:sales@forms-surfaces.com) or contact us at **800.451.0410** with any questions.